

BUILD STRONG • BUILD SAFE • BUILD SMART WITH INSULATING CONCRETE FORMS



ICFMA DESIGN GUIDE FOR MULTI-STOREY BUILDINGS

ICF-MA.org

ICFMA
INSULATING CONCRETE FORMS
MANUFACTURERS ASSOCIATION

The ICF Manufacturers Assoc.

The Insulating Concrete Forms Manufacturers Association (ICFMA) is the North American non-profit trade association for the Insulating Concrete Forms industry and was founded in 2014 by a dedicated group of manufacturers with the goal of education and acceptance of Insulating Concrete Form in the construction industry.

ICFMA Mission:

The mission of the ICFMA is to promote and enhance the social, environmental and economic value of insulating concrete forms in the North American marketplace.

Foreword

This guide has been compiled by the Insulating Concrete Forms Manufacturers Association (ICFMA) which is a membership organization of ICF manufacturers and other stakeholders in concrete construction. The information presented herein has been collected from a cross-section of industry professionals who are dedicated to the construction of high-performance buildings that employ insulating concrete form (ICF) technology. This effort is only intended to pass along a pool of general knowledge that can assist in the design of ICF/Concrete buildings without endorsing any one ICF brand.

Information presented here is advisory in nature only, and is not meant to (replace, supplant) provisions contained in national or local building codes. In the event that information in this manual conflicts with any building code, the building code provision shall govern.

© 2017 Insulating Concrete Forms Manufacturers Association

Table of Contents

▲ Preface	4
▲ 1.0 Introduction	5
▲ 1.1 Why Use ICFs	6
▲ 1.2 Materials and ICFs	6
▲ 1.2.1 ICF Materials	6
▲ 1.2.2 ICF Companies	7
▲ 1.2.3 Material Comparison Chart	8
▲ 2.0 Design Functionality	11
▲ 2.1 General Characteristics of an ICF	12
▲ 2.1.1 Architectural	12
▲ 2.1.2 Structural	15
▲ 2.1.3 Thermal Resistance	15
▲ 2.1.4 Air Barrier	16
▲ 2.1.5 Vapor Barrier	18
▲ 2.1.6 Moisture and Health	19
▲ 2.1.7 Fire Resistance Rating	19
▲ 2.1.8 Sound Attenuation	20
▲ 2.1.9 Indoor Air Quality (IAQ)	20
▲ 2.1.10 Fastening Strip and Substrate	20
▲ 2.1.11 Security and Comfort	21
▲ 2.1.12 Sustainability	21
▲ 2.2 ICF Applications and Installations	21
▲ 3.0 Building Science	25
▲ 3.1 Thermal Resistance	26
▲ 3.1.1 Thermal Resistance Value	27
▲ 3.2 Energy Performance	28
▲ 3.3 Moisture, Vapor and Air	28
▲ 3.4 Fire Resistance	29
▲ 3.5 Sound Attenuation	29
▲ 3.6 Health and Comfort	30
▲ 3.7 Science of Construction Efficiencies	31
▲ 4.0 Sustainability	33
▲ 4.1 Life Cycle Savings	34
▲ 4.2 Sustainability Programs	35
▲ 4.3 Economical Feasibility Factors	37
▲ 5.0 Structural/Engineering Design	40
▲ 5.1 Standard Design Standards	40
▲ 5.2 Concrete Reinforcement	42
▲ 5.2.1 Concrete	42
▲ 5.2.2 Reinforcement	43
▲ 5.3 Resilient Design	45
▲ 6.0 Code Standards & Testing	47
▲ 6.1 Building Codes	48
▲ 6.2 Acceptance Criteria and ICF Standards	50
▲ 6.3 Testing	51
▲ 6.4 Specification	54
▲ 6.5 Energy Codes	55
▲ 7.0 Glossary of Abbreviations	57
▲ 8.0 Case Studies	73
▲ 8.1 Residential Multi-Storey	73
▲ 8.2 Retail / Commercial	74
▲ 8.3 Institutional	75
▲ 8.4 Hospitality	76
▲ 8.5 Medical	77
▲ 8.6 Military	78
▲ Summary	79
▲ References	79

This is an architectural material selection design guide for the design and construction of multi-storey buildings utilizing insulating concrete forms. The framework of factors in the review and selection of building material involves specific categories, each with defining elements that create the advantages/disadvantages characteristics for inclusion in a project design.

This guide addresses each of these major categories and explains the characteristics and benefits of insulating concrete forms for each.

We hope you will realize and appreciate after a review of this guide that insulating concrete forms are basically a simple concrete forming system that overachieves in any category, both as a building product and one of the main components of the building envelope.

1.0 Introduction

1.1 Why use ICFs ?

In every building design, key members of the design team are involved in the selection process for building materials to suit the design concept and functionality of the building. Each of these members has a vested interest in the fundamental role and properties of the materials selected in this process. The culmination of all of the materials is to provide a synergy greater than the sum of all the parts. In today's energy conscious and sustainable world, the assembly of these parts must meet demands for efficiency, durability and resiliency.

When developing a pro and con list during the material selection process, any material that offers multi-functional attributes and benefits, such as ICFs, then that material should be identified as a top pick.

In answering the question 'Why use ICFs', the main reason, as supported in this design manual, is that ICFs provide multi-functional characteristics, overachieve in all categories, and ultimately provide cost savings for the life cycle of the building.



Characteristics of Insulating Concrete Forms (ICFs):

- ▲ Flexibility in design, any building type, height, and complexity
- ▲ Structural integrity following standard reinforced concrete design principles
- ▲ High performance energy efficiency – thermal resistance and very low air infiltration
- ▲ Sustainability, durability, resiliency, longevity, life safety
- ▲ Environmentally friendly – 40%+ recycled content, plus a recyclable product
- ▲ Code evaluated and approved, full library of third party product and assembly testing
- ▲ High Compatibility with other materials and finishes

- ▲ Synergy with HVAC operating systems, reducing operating time and improving efficiency, reduction of required capacity
- ▲ Speed of construction, escalating occupancy time-lines to promote net income
- ▲ Product availability, trained and experienced installers
- ▲ Health, comfort and security
- ▲ Library of building awards, testimonials and project profiles

In this extensive list, there are still more valuable attributes that are influential in the material selection process that ultimately, will save money in the design, construction and operational phases of the project:

1. The characteristics of an ICF wall assembly eliminate the requirement of some additional building materials and sub-trades on the job site. This directly reduces materials and labor costs on the supply and installation of these materials, plus dramatically improves construction time-lines.
2. ICF construction can be continuous in cold weather, during winter months, without additional hoarding for supplementary heating. Construction time-lines are not offset or influenced by cold weather.
3. An ICF provides a stable substrate for the attachment of interior and exterior finishes resulting in fewer deficiencies due to nail pops and warped wood studs.
4. Fewer materials in the building envelope wall assembly results in less compatibility issues due to environmental fatigue.

We hope through review of this design manual, as these multi-functional attributes of ICFs are further expanded upon, it will be challenging for any member of the design team to not recognize the potential that this simple insulating concrete form technology offers.

1.2 Materials and ICFs

1.2.1 ICF Materials

The design of the ICF materials and block sizes has been engineered, tested and approved to resist the hydrostatic pressure from liquid concrete placement and consolidation in the wall system. All the manufacturing and quality control for ICFs is monitored and continually evaluated by code agencies and third party testing agencies to meet specific building code and recognized acceptance standards. (As referenced by US and Canadian ICF Materials Standards from ASTM E-2634 and CAN/ULC-S717.1)







Expanded Polystyrene (EPS) - the rigid insulation panels are Type II, IX and VII Expanded Polystyrene typically with a density of 1.5 lbs/ft³ (23.2 kg/m³). The insulation has a high thermal resistance rating and the panels are 2 ½" (63.5mm) up to 2 ¾" (70mm) in thickness. Some manufacturers provide thicker EPS panels for higher thermal resistance. The two EPS panels when assembled with the cross-ties will create a flat concrete wall assembly. The virgin EPS bead is expanded with steam and the beads are molded, in pressure molds, with panel type forms incorporating the cross-ties into the EPS panel.

Cross-ties (Webs): The cross-ties are typically made from recycled industrial plastic – polypropylene or virgin HDPE & ABS. The cross-ties are incorporated into the EPS panels and are designed to allow concrete to flow freely through the member, and support the EPS panels. The cross-tie has notches (or seats) for the placement of horizontal reinforcement. Typically, cross-ties are spaced at 6" (150mm) to 8" (200mm) on center and are designed with fastening strips on their outer edge for the attachment of exterior and interior finishes.

Some ICF manufacturers produce knock-down ICF forms and for these the cross-ties that are inserted, on site, into the EPS panels. A knock-down cross-ties provides the versatility to have wider concrete cores than 12" (305mm). Folding cross-ties are also available from some ICF manufacturers.

1.2.2 ICF Companies

The following is a listing of the ICFMA member companies, their website and information on one of their products – a standard form. Refer to each ICFMA members' website for detailed information on the materials and full product line of ICF forms and accessories.

	Standard Form: 16" H x 48" L Concrete cores: 4", 6", 8", 10", 12" Fully Assembled and Knock-down forms buildblock.com
	Standard Form: 16" H x 48" L Concrete cores: 4", 6", 8", 10", 12" Fully Assembled and Knock-down forms foxblocks.com
	Standard Form: 16" H x 48" L Concrete cores: 4", 6", 8", 10", 12" Fully Assembled and Knock-down forms logix.com
	Standard Form: 18" H x 96" L Concrete cores: 4", 6", 8", 10", 12" Fully Assembled and Knock-down forms nudura.com
	Standard Form: 12" H x 48" L Concrete cores: 4", 6", 8", 10", 12", + Knock-down forms quadlock.com
	Standard Form: 12" H x 48" L Concrete cores: 4", 6.5", 8" Fully Assembled superformicf.ca

1.2.3 Material Comparison Chart

- ▲ The goal of this manual is to highlight the features and benefits of insulating concrete forms. To further expand on this, attached is a comparison chart that explores the attributes of other building materials that may be used as the major component of the building envelope. In any comparison, the materials and even costs for materials must be assessed as “apples to apples”. This becomes a little harder, in consideration of all the inherent characteristics of an ICF form. In an “apples to apples” format, all the wall assemblies must be evaluated to the same high performance level. This requires additional materials and labor to construct a wood or steel stud wall assembly, in order to meet the high performance levels of a typical ICF wall assembly. The following is a list of materials and labor required for wood or steel wall assembly, in such a comparison with ICFs:
- ▲ Fiber batt insulation or spray foam insulation
- ▲ Exterior rigid insulation to eliminate thermal bridging
- ▲ Interior vapor barrier
- ▲ Exterior air barrier
- ▲ Additional caulking to seal wall plates and sills
- ▲ Additional materials for structural rigidity, lateral loads, etc.

Efficiencies Gained by ICFs vs Wood	
Required Components Added to Wood-Frame	ICF/Concrete Provides
• Moisture Barrier (building paper)	✓ Exempt by Code
• Insulation	✓ R-22 to R-59
• Vapor Barrier	✓ EPS is Rated Barrier
• Air Barrier	✓ Zero Porosity Proven
• Fire Barrier	✓ UL/ULC 2hr. to 4hr.
• Sound Barrier	✓ STC 50+

Similarly, for the other main building systems additional materials are required to make the wall assembly comparable to an ICF. The main consideration in this ‘apples to apples’ scenario breaks down to time and money. All wall systems can be designed and built to meet specific requirements but at what cost? Other materials require extra materials, extra labor and additional sub-trades to assemble these comparable walls.

In the selection of building materials for any building, not only multi-storey buildings, product characteristics are a very important element of the design, however, the race for the return on the investment is the ultimate goal. Any building product, such as an ICF, that can contribute directly improving property assessment values, expedite the time-line for occupancy to

generate cash flow and provide net utility cost savings for the life cycle of the project has to be a 'shining star' or 'apples' in any design and product comparison list.

Review the Material Comparison Chart along with all the sections of this manual, to gain a full understanding of the benefits of ICFs.

Material Comparison Chart

This comparison chart addresses specific building material characteristics as the main component of the overall wall assembly.

Features	Masonry (CMU)	Steel	Wood	Reinforced Concrete	ICF
Building Mass	massive	light	light	massive	massive
Modular	yes	custom	nominal and engineered units	flexible	modular and flexible
Reinforcement	limited space for minimal reinforcement	cross bracing and stiffeners required	lateral supports, corner bracing, hurricane and seismic anchors	flexible for minimal and additional rebar	flexible for minimal and additional rebar
Design Flexibility for openings	controlled application, stacking	flexible	flexible with some limitations	flexible with some limitations	flexible with some limitations
% openings	restricted by % wall area	flexible	flexible with some limitations	restricted by % wall area	restricted by % wall area
Fire Resistance Rating	good, rated assemblies	low fire resistance	low fire resistance	good, rated assemblies	good, rated assemblies
Thermal Resistance	low - requires additional materials and insulation to meet minimum reqmts.	low - requires additional materials and insulation to meet minimum reqmts.	low - requires additional materials and insulation to meet minimum reqmts.	low - requires additional materials and insulation to meet minimum reqmts.	no additional materials required, exceeds energy code minimums
Thermal Bridging	high levels	very high levels	high levels	high levels	very low to absent

Features	Masonry (CMU)	Steel	Wood	Reinforced Concrete	ICF
Uncontrolled Air Exchange	high requires additional materials to meet minimum reqmts.	high requires additional materials to meet minimum reqmts.	high requires additional materials to meet minimum reqmts.	high requires additional materials to meet minimum reqmts.	very low no additional materials req'd.
Moisture Penetration	yes - requires additional materials to meet minimum reqmts.	not applicable - requires additional materials for wall assembly to meet minimum reqmts.	high - requires additional materials to meet minimum reqmts.	low - requires additional materials to meet minimum reqmts.	high protection with flashing and finishes
Mold Resistance	good	excellent	poor	excellent	excellent
Sound Attenuation	low - requires additional materials and finishes to meet minimum reqmts.	not applicable - requires additional materials for wall assembly to meet minimum reqmts.	low - requires additional materials and finishes to meet minimum reqmts.	low - requires additional materials and finishes to meet minimum reqmts.	standard application with gypsum board meets minimum code reqmts.
Durability	good	medium	low	better	best
Resiliency	medium	medium	better	best	best
Construction Speed	slow	slow	medium	better	best
Timeframe to Weather tight building	slow, requires additional materials and sealing	very slow, requires additional materials and sealing	slow, requires additional materials and sealing	slow, requires additional materials and sealing	very fast, once the windows and doors are installed.

2.0 Design Functionality

The overall design process begins with a conceptual design, evolves into the functionality of the design, and then ultimately into the functionality and selection of the materials to assemble/construct the building. In the selection of the materials a full criteria matrix must be evaluated and approved by the whole design team to derive the appropriate building materials.

Material Selection Criteria Matrix

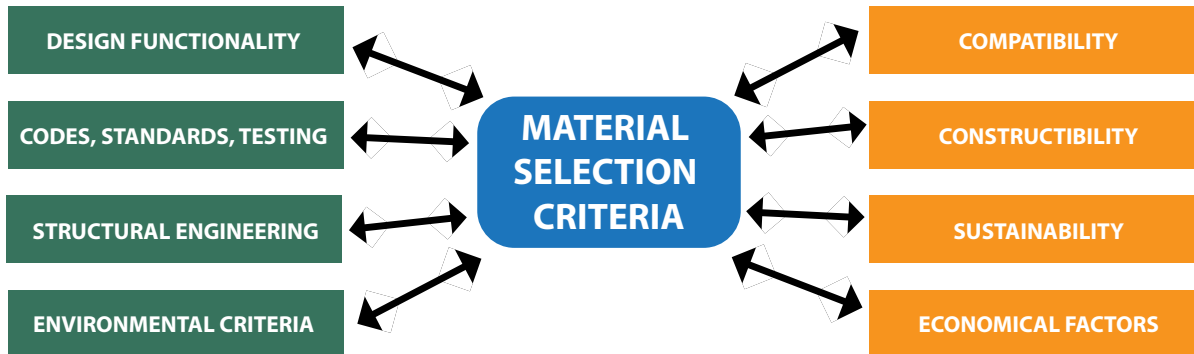

The walls and wall assemblies are the major element of the building envelope. The design may be developed from a complex array of multiple materials that are required to be compatible and work in unison to meet all the functionality requirements of this matrix. There is an inherent risk in constructing a wall assembly of multiple parts that must act and re-act to environmental conditions, interact with each other, be installed correctly, remain durable and sustainable, plus meet all the criteria in the selection matrix.

“Optimizing components in isolation tends to pessimize the whole system - and hence the bottom line. You can actually make a system less efficient, simply by not properly linking up those components. If they’re not designed to work with one another, they’ll tend to work against one another.”

- Hawken, A. Lovins, 1999 Natural Capitalism

There is a considerable amount of building science involved in creating a wall assembly. There is solace in thinking simple, per this quote – The famed architect, Frank Lloyd Wright, was not specifically talking about wall assemblies but premise may be applied to today’s complex assembly of parts and materials, justified, to make a high performance wall.

“...reduce the whole of its parts into the simplest terms, getting back to first principles.”

- Frank Lloyd Wright

Reducing the whole of a wall assembly to the simplest of terms relates to the synergy of an insulating concrete form wall. ICFs meet all criteria in the matrix and over achieves in some categories. In review, the characteristics of an ICF, as the main element of the wall assembly, it provides a risk free viable option for any and all building types.

2.1 General Characteristics of an ICF

As this section begins to list all characteristics provided by the combination of an insulating concrete form and the reinforced concrete, the '**wow factor**' for the multi-functional abilities of these products will become evident.

Each member company of the ICFMA manufactures a full array of ICF forms and accessory products to meet the codes and standards as detailed in this manual. Each of the products has unique design attributes that distinguish it from other companies' products. We encourage visiting the website of each of the ICFMA members to find detailed product specific information.

2.1.1 Architectural

Manufacturers of ICFs strive to make their products unique and special. In doing so, there are various differences in the products that distinguish one company from another. The functionality, characteristics and applications of the products are all similar. The differences address size, cross-tie connection, interlock design, thickness of the EPS insulation, and available accessories.

Forms are generally available in two overall lengths, either 48" (1220mm) or 96" (2440mm). There are a variety of heights for a typical form – 12", 16", 18" or 24" (305, 405, 460, 610mm). Forms are available in a number of concrete core sizes - 4", 6", 8", 10", and 12"+ (100, 150, 200, 250, 305mm). The most common ICF is a 'flat wall' type form with a monolithic flat concrete core, which follows standard reinforced concrete design criteria.

The Type II, EPS insulation panels are available in various thicknesses – 2 ½", 2 ⅝" or thicker. Each panel has a uniquely designed interlock along the top and bottom edge that allows the forms to bind together during placement preventing movement, and provide a tight bond. Some interlock designs are reversible, which means there is no specific top or bottom, or right or left side. The EPS has a flame retardant additive that raises the ignition temperature to be much higher than wood.

The forms are held together with cross-ties (webs), typically made from recycled industrial polypropylene plastic. The cross-ties are molded into the EPS panels and are spaced within the form at either 6", 8", or 12" (150, 200 or 305mm) on center. The cross-ties have notches spaced across the form cavity to accept the placement of horizontal rebar of multiple sizes, securely locking rebar in place to satisfy lap requirements.

ICF companies manufacture a full range of form types – standards (straight forms), corners 90° and 45°, corbel brick ledge forms, taper top forms, and a full range of ICF accessories. Form types and sizes offered by each company are compatible (within their product line) and they have the ability to transition from one size to another, if the design warrants.

ICF forms are also available in two types - as fully assembled forms or knock-down forms. Typically, the fully assembled form is used on most projects but the knock-down form has advantages for cost savings on shipping and the ability to provide alternative thickness for the EPS panels on the interior and exterior. A knock-down must be assembled on site.



To address some of the design criteria for multi-storey buildings, ICF manufacturers have developed a unique one-sided ICF form with a removable plywood layer. Once the concrete has cured, the plywood layer is removed to expose the concrete. This form type is used for elevator or mechanical shafts, stairwells, mechanical and electrical rooms, parking areas under the building, and other areas where non-combustible materials are required.

ICFs provide flexibility in the design for wall lengths and heights. The variety of products allow for any type of wall design, even radius walls. The EPS of the forms is easily cut to shape sculpted parapets, arched window openings and other configurations without complicated form support or special tools. Some manufacturers produce pre-formed radius forms in fixed sizes.

To assist in the architectural design and drawing, each ICF manufacturer has available a full library of product and applications details. There is no need to re-invent the wheel when using ICFs. In most applications and product interfaces, the technical expertise within an ICF company has developed a detail and applied it to a project. Each company has a team of ICF technical experts to assist in any project design, working drawings or on-site build. In addition ICF companies have collaborated with other building material manufacturers to develop details, specification and approvals for the application of their materials with an ICF.

ICFs have also been developed into BIM and other CAD software programs, which are available for download and implemented for design and working drawings. Architects and

engineers should review the ICFMA members' websites for information on detail design libraries and ICF technical support.

With respect to the architectural design, as a modular product the most economical design would suit the form coursing dimensions in length and height. For length, this is generally not possible, but the forms can be easily cut to suit any dimension. Part forms, cut vertically, can be used anywhere in other wall assemblies. For height, the forms are installed from the top of the footing to the underside of the roof system. To meet this specific height only the top course or bottom of forms may have to be cut. Any forms cut horizontally, because of the reversible interlock, can be used elsewhere on the wall, if the size is applicable.

Optimize Building Design vs Materials to Create Efficiencies

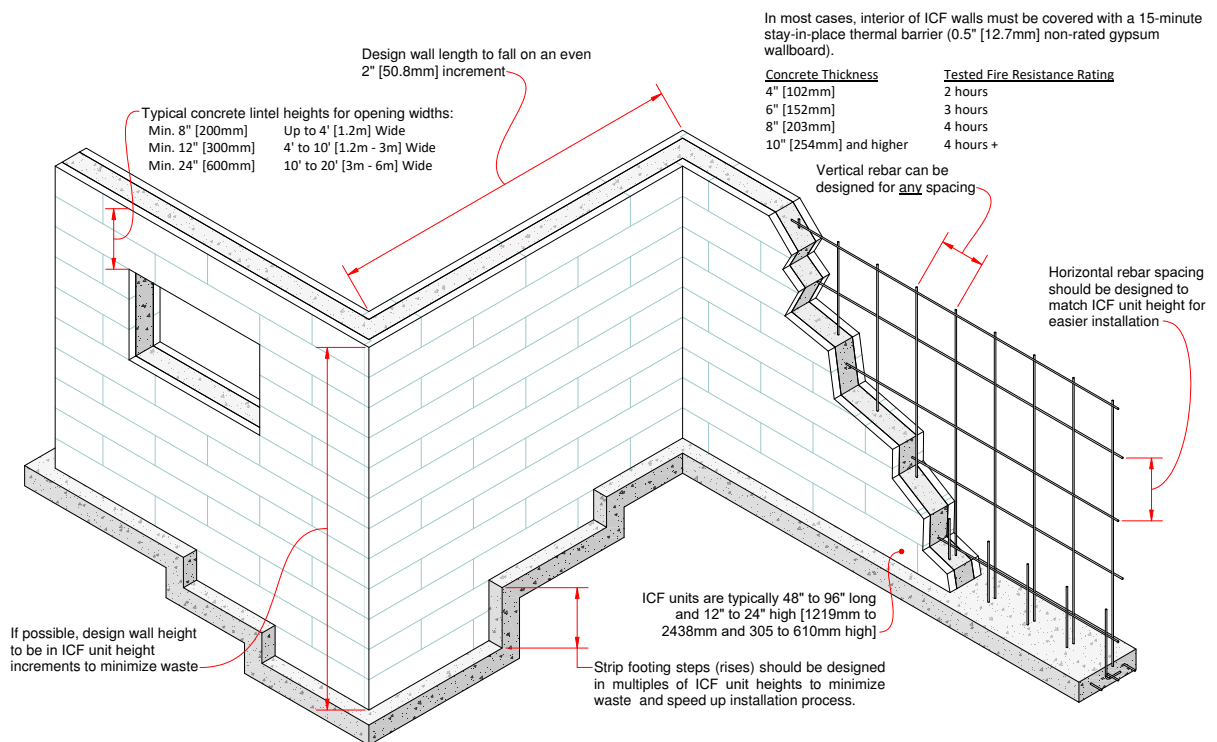

ICFs minimize waste, in the assembly of the wall system for any building of any size, due to the modular sizes and the reversible interlock. Cut blocks and pieces can be integrated in other areas of the building. Any EPS waste, in some locations, can be recycled. This all leads to a clean and safe work site.

As for openings, the forms are easily cut to suit any size and shape of opening. There are various ICF buck materials on the market to close the edge of the ICF around an opening and eliminate thermal bridging at these locations.

2.1.2 Structural

Section 5 of this manual details the structural design standards and criteria for ICFs. The forms are specifically designed and tested to support the hydrostatic pressure of liquid concrete. The versatility of concrete core sizes allows for any design load for multi-storey buildings, tall walls and foundation walls. A big advantage from the insulating forms is better hydration of the concrete, producing a high early strength and even higher sustainable strength after 28 days. The ability of the insulating panels to protect the concrete from the weather adds to durability of the entire wall system. The reinforced concrete core adds resiliency, durability, increased life safety, strength and security to the building.

2.1.3 Thermal Resistance

The key element function of this forming system is the EPS insulation. At a minimum the EPS panels are 2 ¼" (64mm) thick, made from Type II expanded polystyrene beads. EPS is expanded through a steam process and fused together in molds to form the panels. The tested thermal resistance R-value of EPS is R4.1 per inch, this equates to an R-value of R 21 (based on a 2 ¼" thick panel) for the two ICF panels. Energy codes now recognize the whole wall assembly in establishing the thermal resistance factor, so as whole wall assembly a 6" (150mm) concrete ICF with 2 ½" (64mm) EPS panels has an R-value of R24.1.

The advantages for thermal resistance with an ICF are:

- ▲ Continuous insulation on both sides of the wall
- ▲ No thermal bridging
- ▲ No air infiltration due to the continuous concrete
- ▲ Thermal mass of concrete

Control Heat Gain/Loss

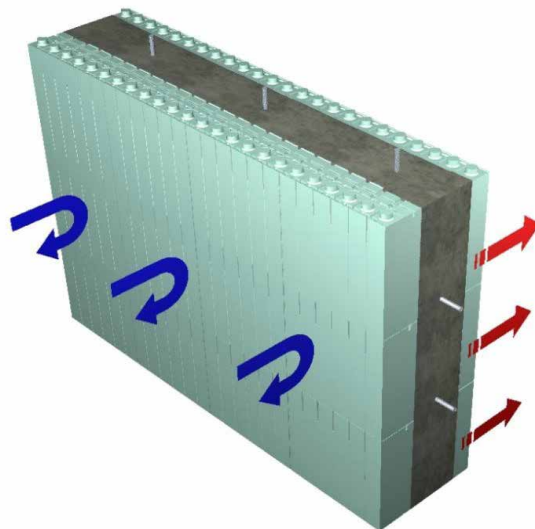

Field testing on an ICF wall assembly was completed by the NRC (Report NRC rr362) that concluded the insulated concrete thermal mass does assist in the delay of the

temperature transfer through the assembly, verifying the 'thermal lag' theory. This minimizes the change in temperature in the habitable space, reducing the load on the HVAC system, saving energy.

Some ICF manufacturers produce thicker EPS panels or EPS insert and in using a knock-down form the EPS panels may be sized differently to suit the climate zone with the exterior panel being much thicker than the interior panel. There is also a new EPS bead on the market that has a graphite additive that increases the R-value per inch of the EPS.

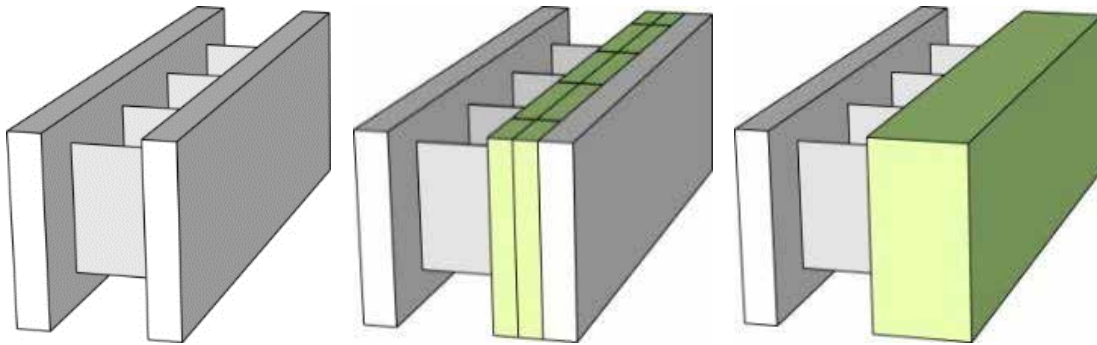

2.1.4 Air Barrier

Air infiltration is one of the key attributes for energy efficiency as evident by the requirements for modeling and testing in the energy codes. Concrete is a natural air barrier and in an ICF wall assembly the monolithic concrete is continuous from the footings to the roof system. The measured air infiltration on an ICF building, with quality windows and sealed service penetration is amazing, well exceeding required standards.

The charts below indicate testing on a three storey ICF building with a basement parking garage. The building volume is 565,950 cu. ft. Testing was completed by ThermalWise Building Energy Savings (thermalwise.ca) per ASTM standards. Note how ICFs exceed the comparative values for a Passive House, USACE Military Specifications and R-2000.

Figure 1

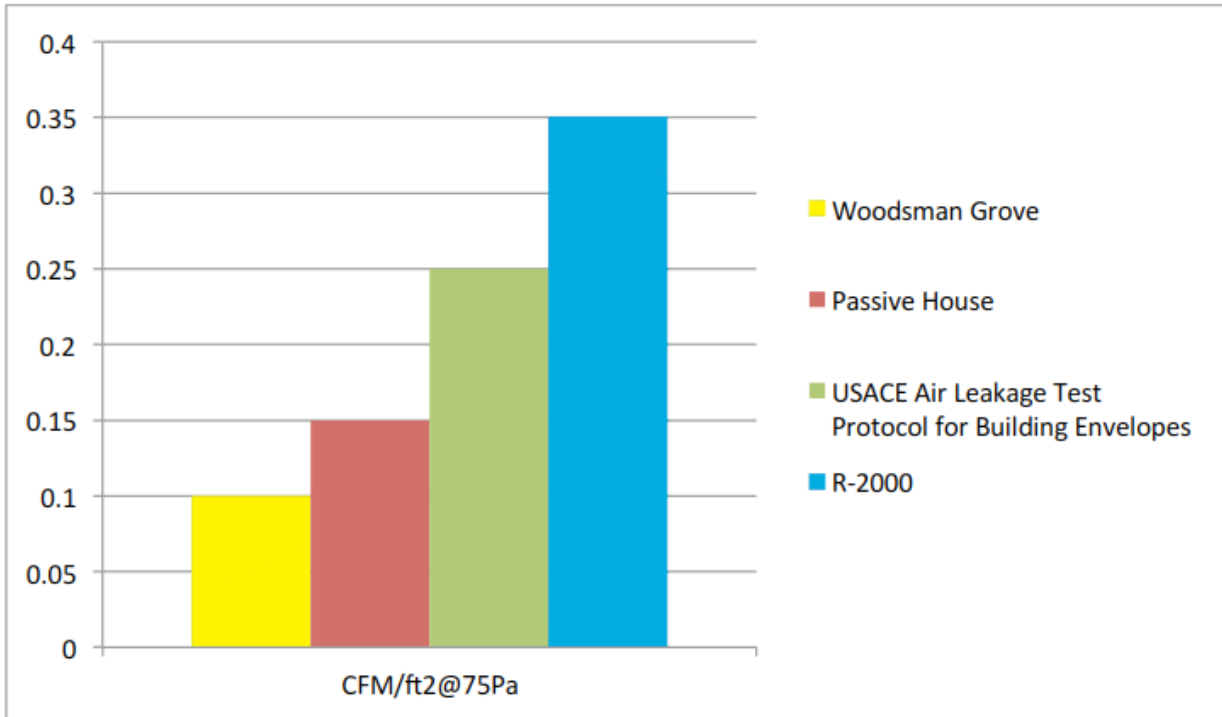

Comparative Bar Chart – Normalized Air Leakage @ 75 Pa
ICF Building Woodman's Grove – 0.1 CFM/ft²@75Pa

Figure 2

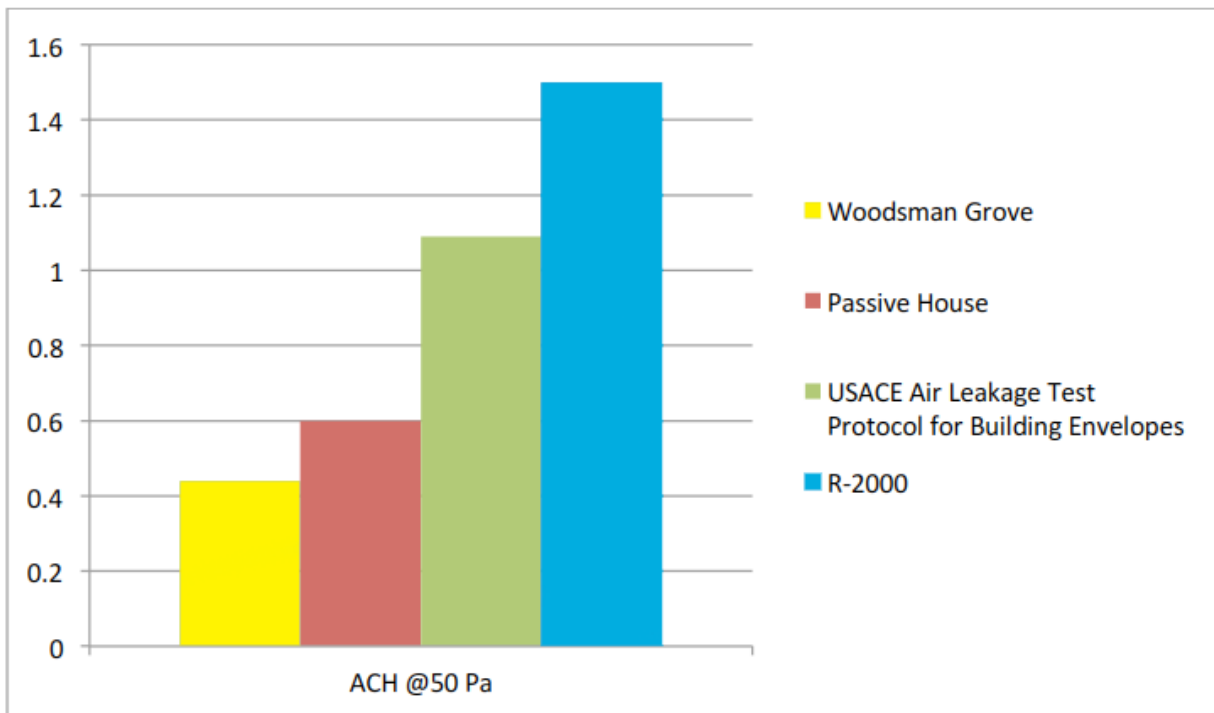

Comparative Bar Chart – Air Change Rate per Hour @ 50 Pa
ICF Building Woodman's Grove – 0.44 ACH@50Pa

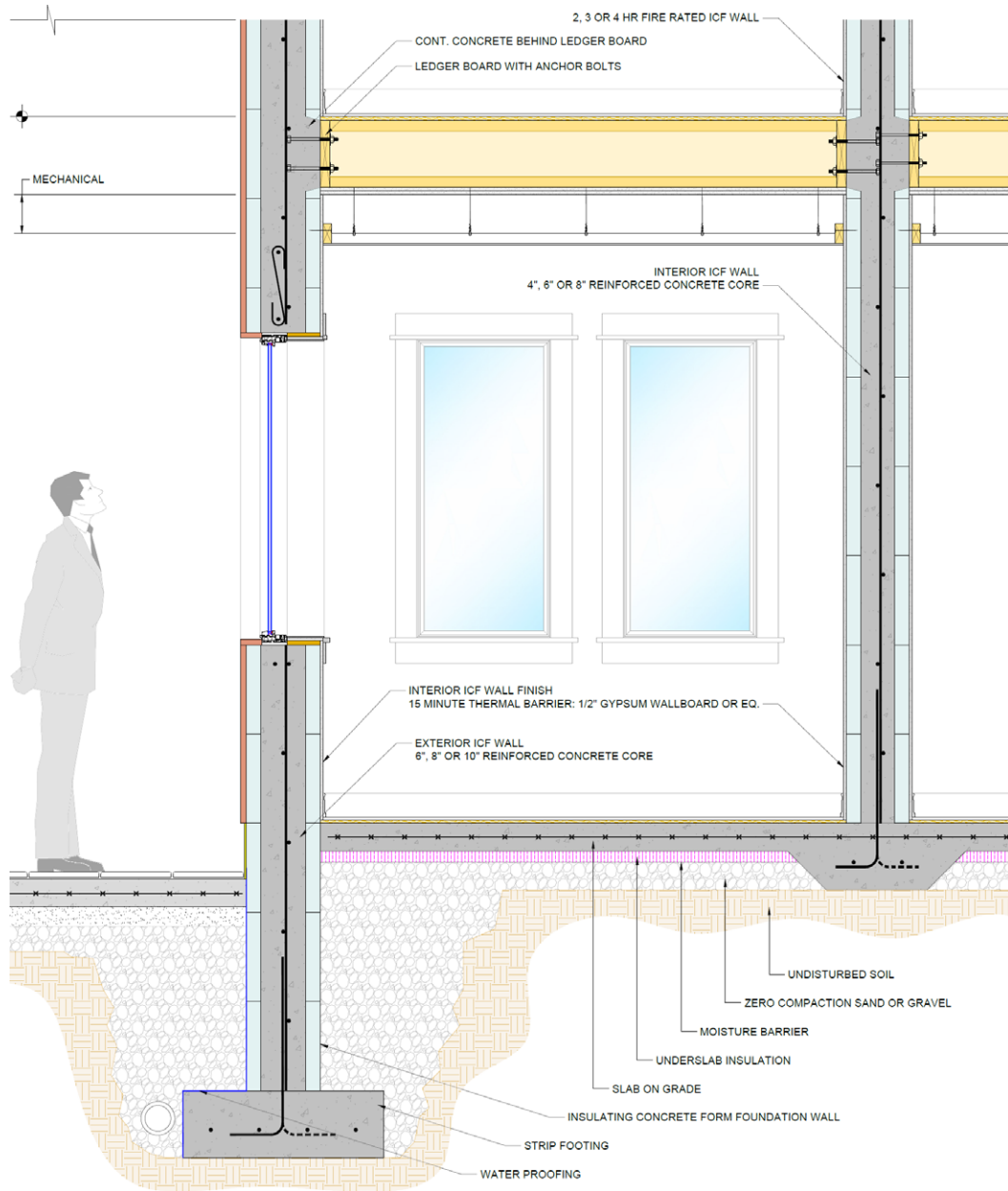

2.1.5 Vapor Barrier

The concrete core and the EPS insulation function as a continuous vapor barrier and provide vapor diffusion resistance to control condensation through the wall assembly. The dew point in an ICF wall is toward the exterior face, either in the exterior EPS panel or the exterior side of the concrete layer. The low vapor permeance rate eliminates the requirement for any additional air or vapor barrier materials being applied to an ICF wall assembly.

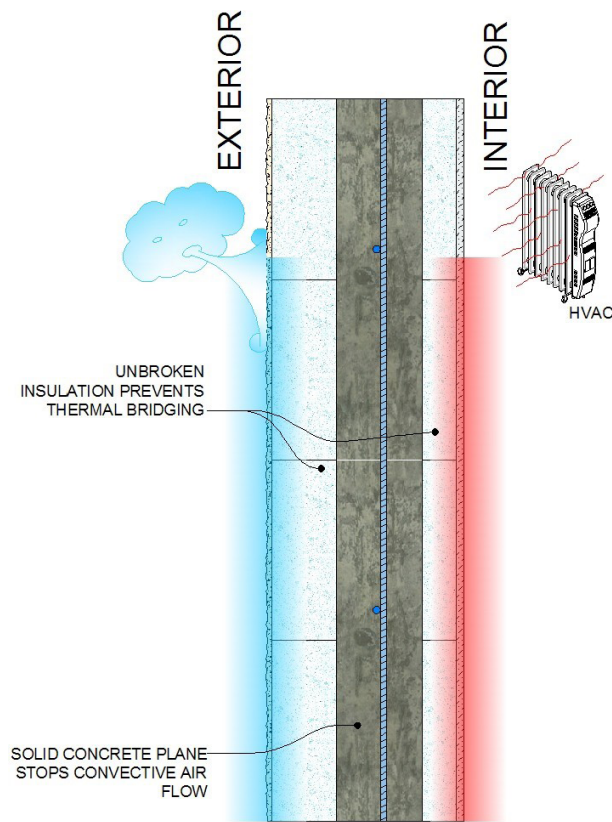

ICF WALL

2.1.6 Moisture and Health

With respect to floods and water, concrete is not affected by water. Concrete will retain its' strength and durability, drying evenly on its' own. Neither concrete or EPS insulation are food sources for mold or mildew. EPS is an inert product. Any ICF walls that are subjected to floods will not degrade or rot and can be easily cleaned and re-finished.

EPS as the substrate for the exterior finishing materials sheds moisture. The detailing for flashing and sealing around openings has been tested, in engineering laboratories, under high wind and pressure applications. The results confirmed that moisture intrusion at these areas was not an issue when detailed as per ICF manufacturers' specifications.

2.1.7 Fire Resistance Rating

Concrete is naturally resistant to fire. ICFs with the EPS panels as plastic insulation have been addressed in the building codes and ICFs comply and have been approved for smoke development and flame spread per ASTM standards. In all habitable spaces the EPS must be protected with a 15 minutes thermal barrier which is typically ½" (12.5mm) gypsum board.

ICF manufacturers have also completed fire resistance testing for fire rated wall assemblies for 1, 2 and 3 hour rated walls. These tested wall assemblies for all concrete core sizes typically only required the addition of regular ½" or ⅝" (12.5 or 16mm) gypsum board to the interior side of the wall.

ICFs may be used for any design application for non-combustible buildings that requires a fire rated wall assembly.

2.1.8 Sound Attenuation

A simple ICF wall assembly with a 6" (150mm) concrete core and ½" (12.5mm) gypsum board on both sides provides an STC 50 rating. To enhance the STC, upgrade the thickness of the gypsum board or add resilient channels to one side of the wall. Occupants of an ICF home or apartment can testify to their appreciation the quietness of living in an ICF environment. For multi-occupancy buildings this has become a major sale advantage.

2.1.9 Indoor Air Quality (IAQ)

The fact that an ICF building envelope is very air tight and energy efficient allows for better control and monitoring of the indoor air quality. Having the ability to down-size the HVAC equipment, due to the high performance of the ICF wall assembly, cuts initial capital costs and because the HVAC systems do not have to work as hard or as often, substantial utility savings are accrued for the life cycle of the building.

2.1.10 Fastening Strips and Substrate

Every ICF, standard form and corner form, have molded in to the EPS panels fastening strips as part of the cross-tie. These are typically spaced at 8" (205mm) on center, and are on both sides of the form. When the forms are installed, these fastening strips will line up for the full height of the wall. The fastening strips are buried just below the surface of the EPS to prevent thermal bridging and the location is indicated on the face of the EPS. ICF fastening strips have been tested for lateral and withdrawal loads in test labs per ASTM and code standards. It is recommended that the best application for all material is with a screw. The application of interior gypsum is directly applied to the ICF and fastened with regular gypsum board screws 1 ⅝" (41mm) long. Because the ICF provides a solid backing for the gypsum board there is a more solid integrity to the wall assembly and with the fastening strips made from plastic, nail pops are eliminated, creating fewer deficiencies and better quality.

The EPS as a substrate can be used for the direct application of acrylic and hard coat stucco products. Any exterior finishing material may be applied directly over the EPS substrate and attached to the fastening strips. For masonry, specific ICF hangers are available that are cast into the concrete from the ICF manufacturers.

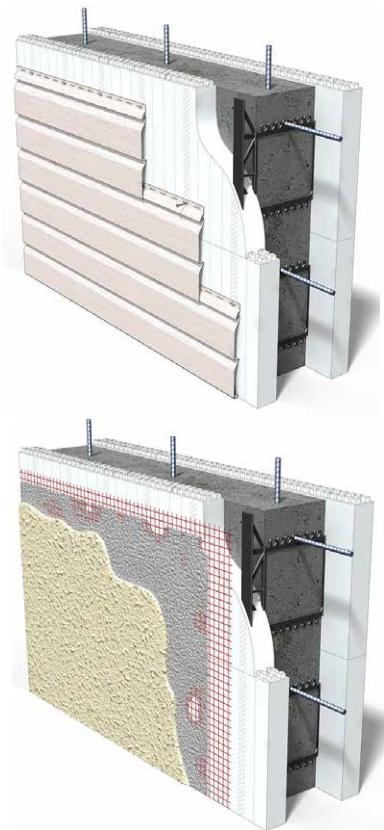

2.1.11 Security and Comfort

The US military conducted blast testing on ICFs, that confirmed a 6" (150mm) concrete core ICF wall can withstand and remain structurally stable after a blast from 50 pounds of TNT from 6' (1800mm) away. There has also been testing by Texas A&M for high wind debris which shoots 2x4s from a canon at the wall assembly. ICFs passed by preventing the 2x4 from penetrating the concrete. The reinforced concrete walls of an ICF can be designed for wind speeds of up to and over 350 mph.

In combination with the all characteristics listed above, an ICF building provides security and a comfortable environment to the inhabitants.

2.1.12 Sustainability

The main attribute for sustainability for ICFs is the simplicity of the product. In comparison to conventional construction using wood or masonry, the characteristics and installation of ICFs, simply EPS and concrete, eliminates the need for multiple materials and numerous sub-trades to assemble a high performance wall system. This delivers comparable first cost and life cycle cost savings, durability and resiliency. Refer to Section 4.0 for more information on Sustainability.

2.2 ICF Applications and Installations

The unique aspect of an ICF, as a reinforced concrete wall assembly, is that there are no limits to the products applications. ICF first started as a foundation wall applications, designed to retain backfill. The product then graduated to be used for the first and second floors in residential construction. As the markets grew and more engineering and technical expertise became interested in ICF construction the uses and applications have grown exponentially without limitations.



As ICFs grew in the commercial markets they have been used for all building types:

- ▲ Institutional – schools, colleges and universities
- ▲ Medical – hospitals, medical centers, laboratories
- ▲ Hospitality – motels, hotels, community centers

- ▲ Commercial – banks, retail stores, big box stores and malls, office buildings, fire stations
- ▲ Residential – multi-story townhouses and condos, apartment buildings, student residences
- ▲ Industrial – warehouse, controlled storage facilities, aircraft hangers, manufacturing plants
- ▲ Agricultural – animal barns, produce storage, digester tanks
- ▲ Military – housing, storage, secure office buildings and warehousing
- ▲ FEMA – safe rooms, community shelters
- ▲ Net Zero energy housing and commercial office buildings
- ▲ and more...

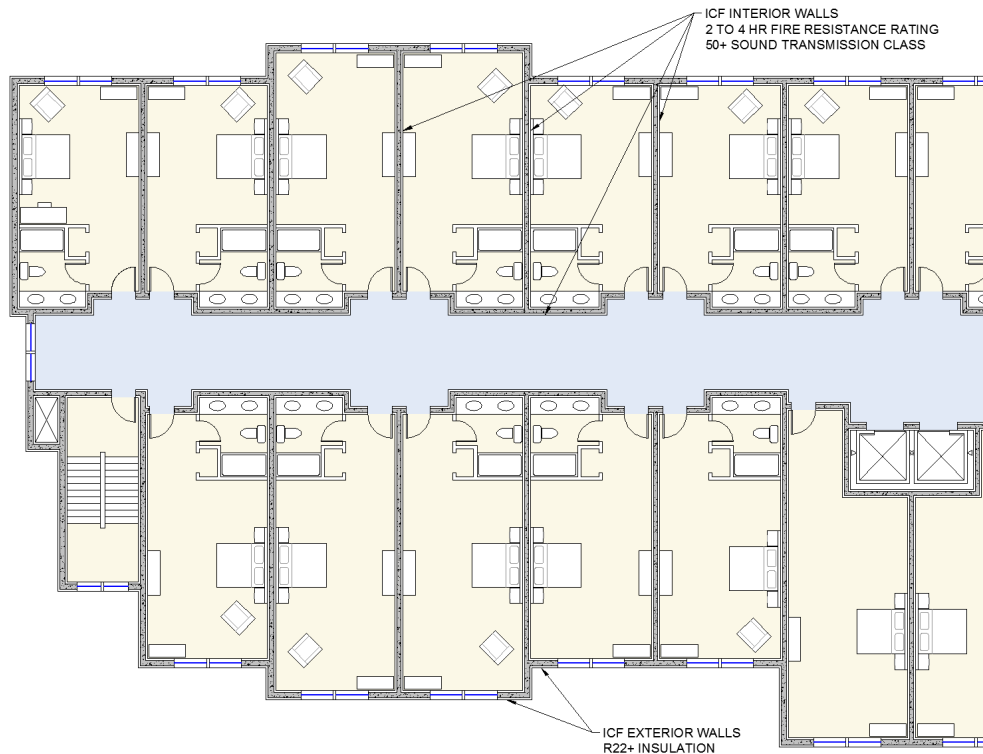

The versatility and characteristics of an ICF opens up all avenues for the design community to apply ICFs for any building type in any configuration. Over the last few years ICFs have been the product of choice to build student residence buildings in Waterloo, Ontario. Over twenty high rise buildings have been constructed between 10 to 25 stories high, mostly utilizing a precast flooring system with ICF load bearing exterior walls and in some cases interior ICF bearing walls, plus elevator shafts.

Some of the main reasons, among many, for the popularity of ICFs in these multi-storey applications is:

- ▲ Speed of construction
- ▲ Ability to build continuously and place concrete through the winter
- ▲ High energy performance benefits and utility cost savings
- ▲ Greater awareness of ICFs and construction knowledge
- ▲ Comparable first cost construction with significant speed and long-term ROI

Speed of construction is one of the biggest benefits when building with an ICF. Placing one typical form, installs over 5 sq.ft. of wall. For these multi-storey buildings, with a large floor plan, crews were installing the ICF walls and the precast floors at a pace of one floor per week.



The installation process for ICFs is very simple – place the ICF forms, install rebar, cut openings, install bucks in openings, if required install embeddings and service sleeves, place and consolidate the concrete, prep for next wall assembly and allow concrete to cure, then place the precast floor system.

Not only is the construction of the building shell and the floors accelerated but the installation schedule for the windows and doors is advanced. Once the windows and doors are installed the building is weather tight and the interior finishes, electrical and mechanical can start to be installed. It is at this stage in the construction that the completion schedule, in comparison to conventional construction (wood, steel or masonry) is possibly advanced by not weeks but months.

Faster building completion results in major benefits for net financial gains in not only construction costs and financing but also from faster income generation through earlier occupancy. ICFs provide this advantage.

“There are a great many things about architecture that are hidden from the untrained eye.”

Frank Gehry

There are a great many things about an ICF that are hidden from the untrained eye. The functionality, characteristics and applications are extensive, and possibly unfamiliar to design professionals, developers and owners. Once, one becomes familiar with this material capabilities, it will reveal a great many things.



3.0 Building Science

Everyone involved in the development of a multi-storey building design aspires for the design, functionality and operation of the building to meet their specific goals. The complexity in the selection and application of building materials has become more intricate with respect to the building science and the interface of each material in the overall assembly. The incentive in any design is to minimize risk and optimize sustainability and costs, both in the construction phase and the life cycle operational phase for the building including providing a healthy and comfortable environment for occupants.

Conventional wall assemblies have become multi-faceted and subsequently imply more risk, not only on the functionality of each of the materials but the detailing for the application and actual installation.

Building science involves the strategic assembly of materials to create a functioning building envelope. A conventional wall assembly, to meet minimum code and energy requirements, has a minimum of five separate and individually designed and installed building materials:

- ▲ Exterior weather barrier or building wrap
- ▲ Exterior insulation (rigid)
- ▲ Structural component (wood, steel or masonry)
- ▲ Interior insulation (batt or spray foam insulation)
- ▲ Vapor barrier (poly film)

All of these elements, in a conventional wall assembly, contribute to the science and operation of the building envelope. Each material must be individually specified, selected, detailed and generally, will be installed by a separate sub-contractor. These five dissimilar materials, having differential characteristics for temperature shrinkage, air and moisture pressures and must be installed correctly, individual joints sealed together to function successfully as the whole multi-storey wall assembly.

The more materials involved in the building envelope, the higher the cost and an increase in risk for the building science of the whole assembly.

In reviewing the development of materials and configurations for a conventional wall assembly in order to meet revisions to the energy codes and building science requirements, we must turn to the famous quote by Albert Einstein –

“We cannot solve our problems with the same thinking we used when we created them.”

Innovative thinking developed insulating concrete forms. ICFs took something that has proven strong for centuries (concrete) and combined it with something we all know insulates well (EPS foam). The plastic ties or webs evolved to hold rebar appropriately, eliminate thermal bridging and provide attachments zones more often and stronger than wood. The advantages of an ICF are that all of the necessary components, to meet the structural and building science requirements, are built-in to one product and installed by the one contractor.

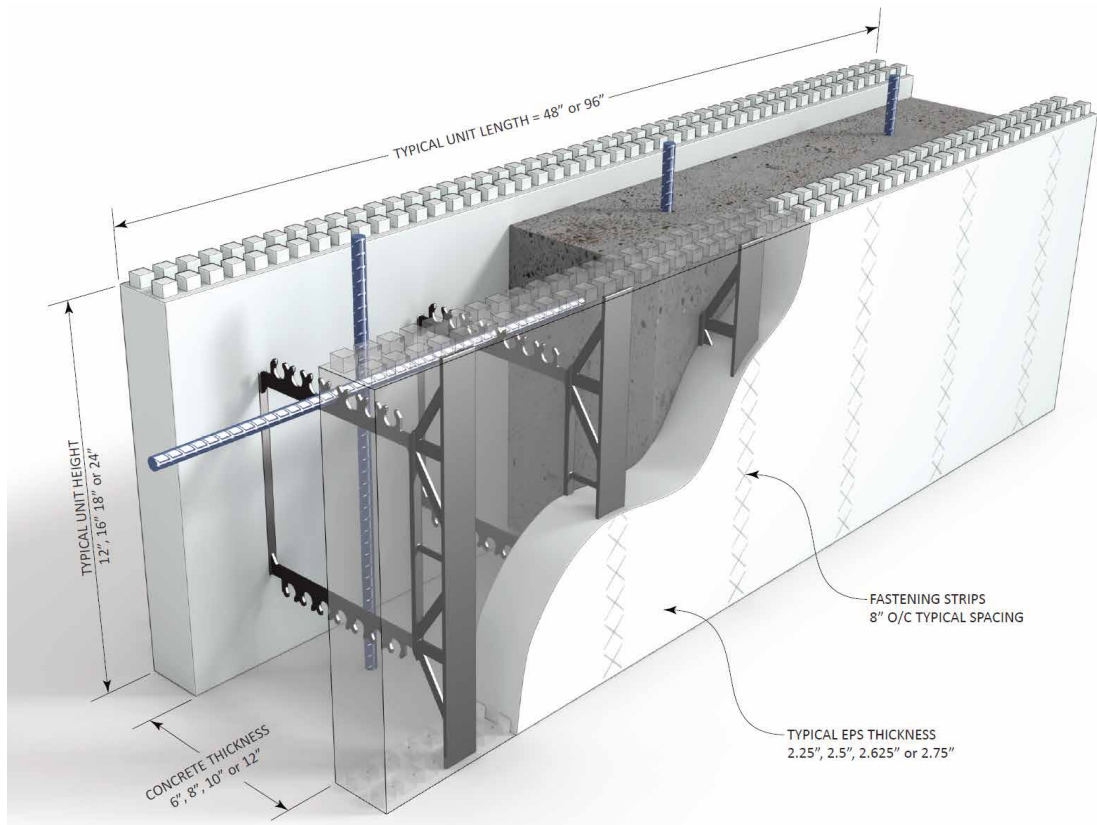

The building science characteristics of an ICF wall assembly, with reinforced concrete, meets and/or exceeds minimum building and energy code requirements. As the singular load bearing monolithic component, with continuous insulation, an ICF building envelope, provides the sustainability attributes listed in this section.

3.1 Thermal Resistance

Insulation is the main component of an ICF, creating exterior and interior layers of expanded polystyrene (EPS) insulation, having a minimal thickness of 2 ¼" (63.5mm), with a density of 1.5 pcf (24kg/m³). The tested thermal conductivity of EPS provides a thermal resistance rating of R4.1 per inch, typically R21 minimum. However, there are specific advantages with an ICF wall assembly that allow the evaluation of the thermal transmittance to consider all the components as a whole wall assembly. These ICF advantages are:

- ▲ No thermal bridging
- ▲ Continuous EPS insulation (2 layers – exterior and interior)
- ▲ Thermal mass of the monolithic concrete
- ▲ Reduced air infiltration provided by the continuous concrete wall

The current model energy codes (NECC and IECC) have been updated to specifically address issues with conventional framing related to thermal bridging and air infiltration, within the whole wall assembly. These codes also recognize ICF walls as mass walls and categorize them

differently than a conventional wood or steel framed wall assembly.

From this assessment (per Table 3.1.1) an overall ICF wall assembly with a 6" (150mm) concrete core provides an R-value of R22.76 (RSI 4.01).

Table 3.1.1 Thermal Resistance Value – Minimum 6" ICF Wall Assembly.

Assembly Elements	Material Thickness	Thermal Resistance per Inch	Thermal Resistance Values
Outside air film	-		0.17
Siding	Minimal	0.6	0.6
EPS insulation	2.5" (55mm)	4.1	10.25
Concrete	6" (150mm)	0.06	0.36
EPS insulation	2.5" (55mm)	4.1	10.25
½" Gypsum board	0.5" (12.5mm)	0.9	0.45
Inside air film	-		0.68
Total Wall Assembly: R-value			22.76
RSI value			4.01
U value			0.249

1. Values are per engineering design evaluation per ASHRAE Standard 90.1, 2010.

Additional thermal performance for an ICF assembly is available by increasing the thickness of the EPS panels. Thickness may be increased on either the exterior panel or both panels. Also available is an EPS bead formulation with a graphite additive that increases the thermal performance per inch of the EPS insulation. These enhancements to a typical ICF have the ability to increase R-values from R23 into an R30 range. Material insulation beyond R30 has diminishing value because the performance characteristics ICFs. The test real world performance of an ICF wall far exceeds the need for higher R-value materials.

The recent Thermal study by CLEB Laboratories quantifies the benefits of BOTH thermal mass and the continuous insulation properties of ICF technology over traditional code compliant wood framed cavity insulated systems. The tests were conducted in strict accordance with ASTM C1363-11 "Standard Test Method for Thermal Performance of Building Materials and Envelope Assemblies by Means of a Hot Box Apparatus."

The reported results comparing the two wall assemblies prove the ICF assembly took nearly 324 hours to reach steady state performance under an exterior air temperature of -31 degrees F (-35 degrees C) whereas the wood frame wall reached steady state within 60 hours of the start of the test.

CLEB's studies have clearly illustrated when comparing the amount of energy required to maintain both walls at steady state over this same 324 hour period, the wood frame wall consumes 149% more energy than the ICF wall. Even AFTER both walls attained steady state under the test conditions, the ICF wall consumed **58% less** energy than the wood framed wall specimen to maintain temperature. Download the full study to learn more about the test results

of the study at icf-ma.org/thermalstudy.

Refer to each ICF company for enhanced thermal resistance performance values, due to increased thickness of the EPS panels using an EPS bead that increases the thermal performance.

3.2 Energy Performance

Thermal performance studies by CMHC and other energy modeling software (WUFI) have shown that the insulated concrete core of an ICF provides a 'thermal lag' in the heat transfer as it penetrates the wall assembly. This function minimizes the temperature change on the interior wall surface, minimizing the temperature swings within the interior of the building. This results in less demand on the HVAC system, providing energy cost savings for the life span of the building.

The combination of high thermal resistance, insulated concrete mass and low air permeance contribute to the overall energy efficiency of the ICF wall assembly. This energy efficiency is measurable in the operating cost savings for the life span of the building, optimizing building design goals for efficiency and performance.

In addition to the on-going operational cost savings, the initial building modeling and HVAC design will reveal a considerable initial capital cost savings by reducing the HVAC equipment capacity. The operating requirements for this equipment can be reduced due to the attributes provided by the ICF wall assembly for thermal efficiency and overall building envelope air tightness.

Some energy modeling programs do not recognize the thermal mass contribution. All modeling should be adjusted to reflect the thermal resistance values and Air Changes per Hour (ACpH) qualities of the ICF whole wall assembly.

The energy efficiencies provided by ICFs, as the integral component of the building envelope, have been documented as real ongoing dollar savings for the life cycle of the building. These energy performance attributes may also contribute to financial incentives, grants and rewards from government and local agencies and utilities.

Energy and operating cost savings are key factors in the appraisal and re-sale value of a building. These on-going cost savings from an ICF building, not only reduce the payback period on the capital investment for construction, but increase the value of the building.

3.3 Moisture, Vapor and Air

This is one of the main areas where the inherent characteristics of the continuous layers of EPS and the concrete core surpass conventional wall assembly construction. In a multi-storey building the internal and external pressures provide a controlled interior environment while being subjected to higher winds, variable temperatures, and air pressures. The materials and assemblies within the wall assembly must be addressed.

The stability of ICFs with a continuous, monolithic reinforced concrete core has the structural capability to resist wind and seismic forces and acts as a continuous air barrier for the building envelope. Air permeance testing on ICF assemblies well exceed minimum code requirements. The overall air change per hour rate (ACH) for a well designed multi-storey ICF building should be in the range of 0.10 to 0.15 ACH. Inputting these lower values into an HVAC design program (Manual J) can substantially reduce the HVAC equipment requirements, resulting in

initial capital cost savings at the design phase.

The ability to control air, vapor and moisture provides efficiencies and better indoor air quality. This results in not only measurable financial savings but inherent comfort for the occupants.

3.4 Fire Resistance

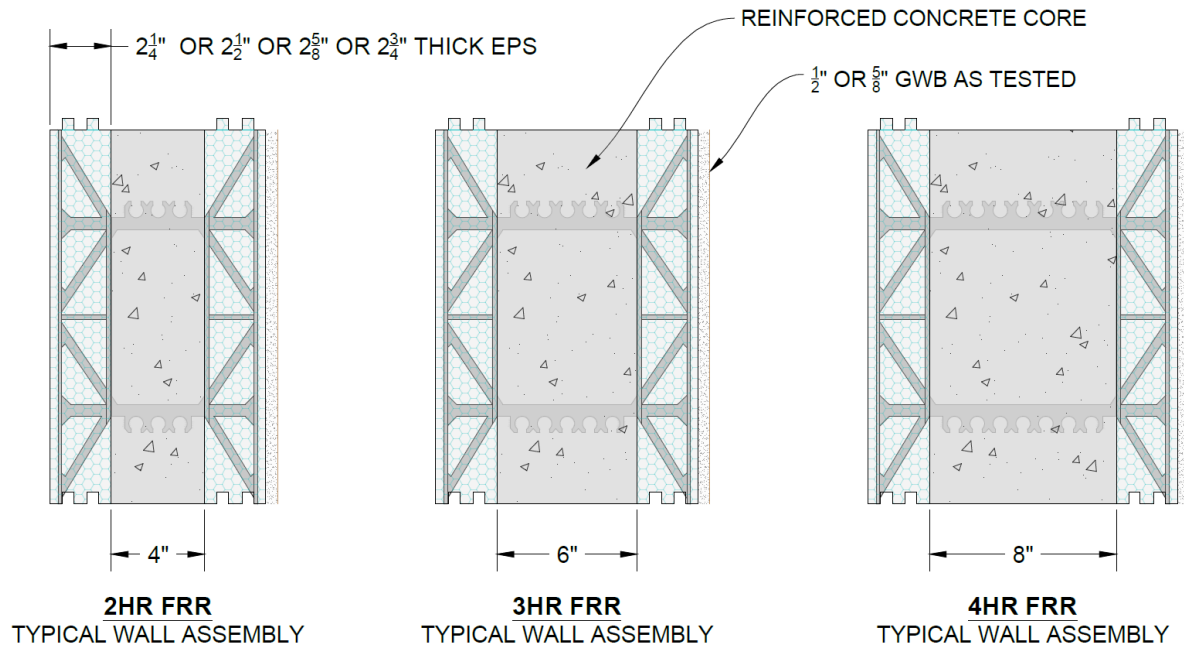

All building types require fire resistance rated wall assemblies for exterior and possibly interior walls. There is also the requirement for flame spread and smoke development of the materials. The ICF industry has addressed all fire and smoke development issues as part of their materials standards and testing requirements. ICF product and/or material testing verifies, that for any building type, of any height, ICFs meet all building code requirements for combustible and non-combustible buildings.

Specific, fire resistance testing (report 5) on ICF wall assemblies for fire ratings to meet a 1,2 or 3 hour rating, with $\frac{1}{2}$ " or $\frac{5}{8}$ " regular gypsum board are available from the ICF company. Fire rated ICF wall assemblies present a great opportunity, in the design phase, to use ICFs as a load bearing, fire rated interior wall, in addition to fire rated exterior walls. For multi-storey applications as a demising wall or firewall, a simple ICF wall is more advantageous to construct for labor and materials than a double stud or solid masonry wall.

3.5 Sound Attenuation

As part of any multi-storey or multiple occupancy building sound transmission is a design consideration and could be a major sales attribute either for the exterior wall or interior demising walls. A typical 6" concrete core ICF with the two layers of EPS insulation and regular $\frac{1}{2}$ " gypsum board wall finish will provide an of STC 50+. ICFs are a simple alternative that meet the building requirement for residential multiple occupancy. In comparison to the additional applications required to enhance a masonry or wood framed wall assembly to meet this level of sound transmission rating.

Upgrading the STC rating on an ICF wall, above the STC 50 rating, has been easily done through a variety of applications - increasing the gypsum board thickness, applying double layers of gypsum board or using a resilient channel. These enhancements have been utilized for demising walls in multiplex theater project, school music rooms, etc.

Building locations may dictate the requirements for sound attenuation from excessive exterior noise such as railways, airports, or major highways. If, by using an ICF wall design, the exterior building envelope has the ability to suppress this exterior noise, the overall building design now becomes more attractive financially for tenants and occupancy. One of the first things a tenant in an ICF building will comment on is how quiet it is.

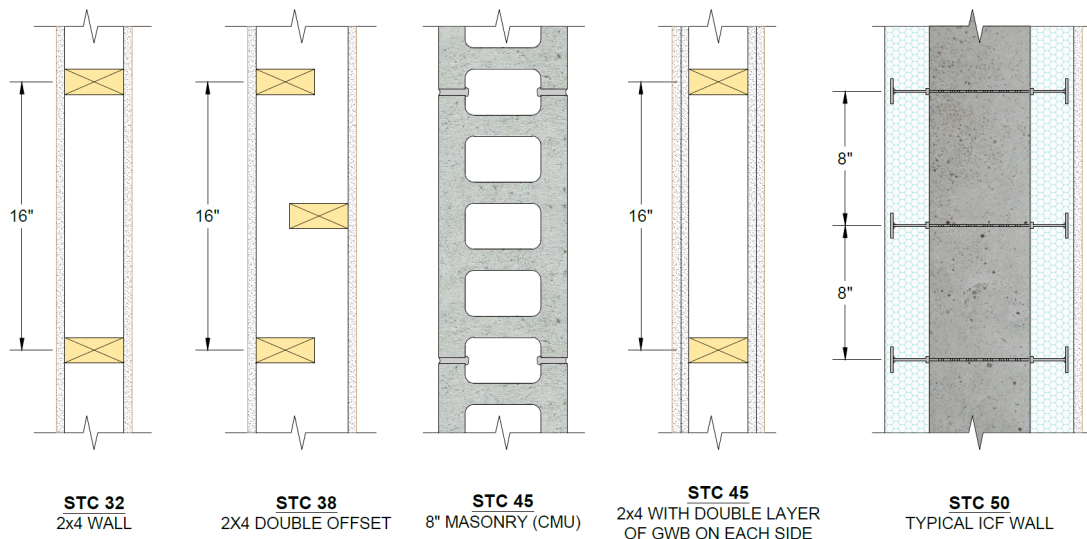

3.6 Health and Comfort

Combining all the attributes offered by the insulating concrete form product or material itself, the two most marketable elements provided by an ICF to the building occupant are a healthy and comfortable environment. There is comfort in the understanding that EPS does not contribute to mold or mildew and will not degrade over time. The very low air changes per hour and air tightness of the building envelope provide better control of the interior environment which improved the air quality. The high thermal performance of the building envelope provides consistent room temperatures, minimizing temperature fluctuations during cold or hot weather and high winds.

The sound attenuation provides a relaxed and comfortable atmosphere devoid of interference from any neighbours or the external environment.

ICFs create an added comfort factor by understanding that an ICF building is reinforced concrete: strong, resilient, fire resistant and designed to withstand high winds or seismic events.

3.7 Science of Construction Efficiencies

The key factor for the construction of any building is the time-line. The time-line directly influences the financial plan and the drive for occupancy and begin to generating income. The selection of materials, contractors, sub-trades and the overall project management will define the ultimate time-line from start to completion.

ICFs provide a measurable acceleration rate to the goal of having the building envelope weather tight enabling the completion and occupancy date moved forward by many weeks or even months depending on the building size.

There are ten characteristics delivered by an ICF wall assembly that contribute to the overall construction efficiency for any multi-storey building:

- ▲ Modular building product
- ▲ Major structural component, exterior and/or interior
- ▲ High performance thermal resistance
- ▲ Air barrier
- ▲ Vapor barrier
- ▲ Liquid moisture resistance barrier
- ▲ Fire resistance rated assembly
- ▲ Sound attenuation rated wall
- ▲ Substrate for direct application of exterior and interior finishes
- ▲ Safer construction site with less waste

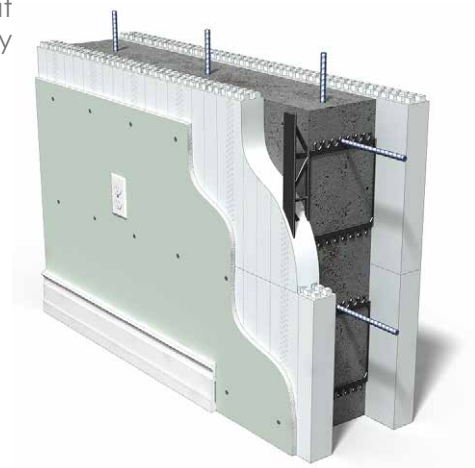

As a multi-functional product, ICFs eliminate other materials required to meet these building science and structural functions, and in doing so, also eliminate the manpower and sub-trades required to assembly the building envelope. Whereas, one experienced ICF contracting crew is all that is required.

As a modular product ICFs create a clean and safe construction site. Designing to suit the coursing for an ICF block offers the ability for less cutting and less waste material. Some ICF blocks are also available with a reversible interlock system that allows cut blocks to be used elsewhere in the wall assembly.

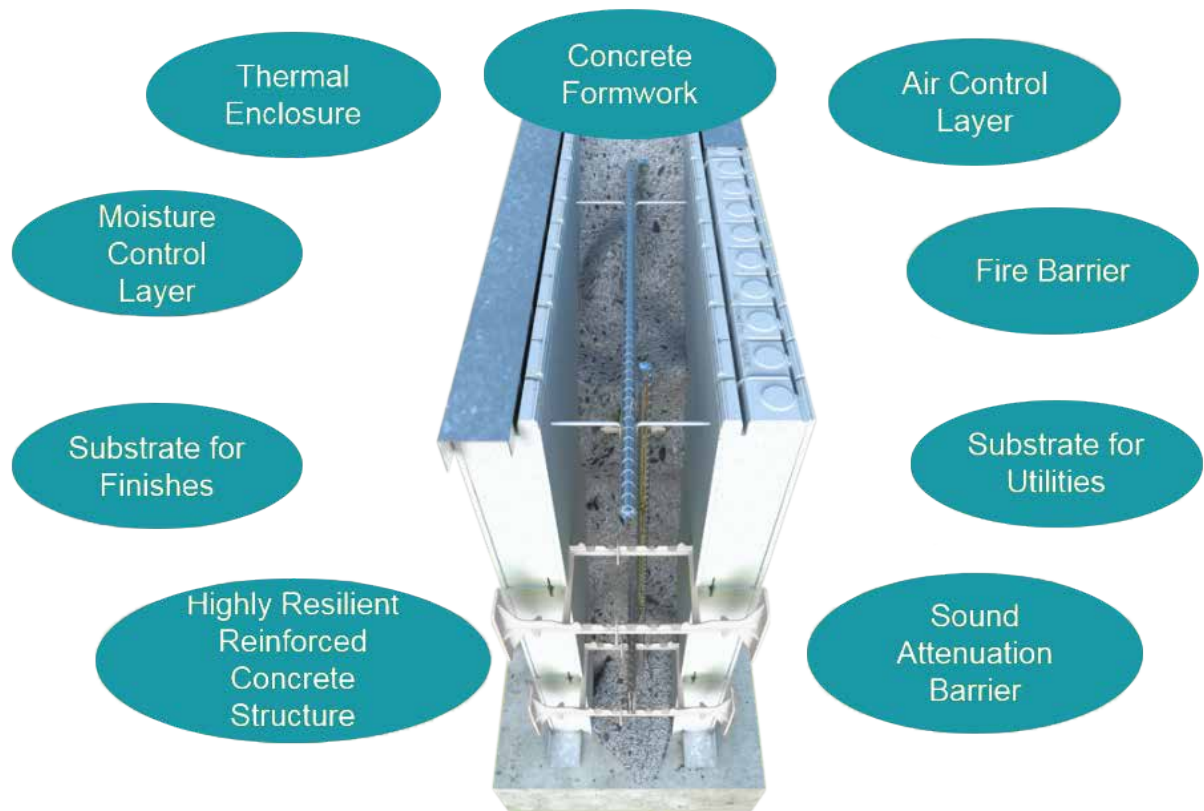

Another major financial advantage in using ICFs is that they can be installed all 12 months of the year. Cold weather construction and the placement of concrete within an insulated forming system is common practice. ICFs extend the building season, expedite the closing rate and minimize the need and cost requirements for supplement heat and hoarding during cold weather construction.

The overall construction efficiency building with ICFs come from these simple equations

Less Materials + Less Labor = Less Construction Time

Less Construction Time + Quicker Occupancy = Less Dollars and Faster Return on Investment

Less Construction Time + Less Dollars + Quicker Occupancy = Faster Return on Investment

4.0 Sustainability

The philosophy and strategic goal in today's design is for sustainability, not only in the overall project design and materials selection considerations, but for the functionality and operation of the building as a whole for the long term. It has been well documented that buildings consume 40-50% of the world's total energy and are a primary source for Green House Gas (GHG) emissions.

"The building sector has the most potential for delivering significant and cost-effective GHG emissions reductions."

United Nations Environmental Program
- Sustainable Buildings and Climate Initiative, 2009

There are many key aspects for consideration in the selection of, environmentally friendly, sustainable materials to be integrated into a design. In the path to sustainability, the design team must develop strategic design and approval criteria in addressing items such as:

- ▲ What is required to create a long term sustainable building design?
- ▲ How to reduce the carbon footprint in the construction and operational phase of the building?
- ▲ What will be the impact on the environment from the materials and/or the completed project ?
- ▲ How to minimize construction waste ?
- ▲ How to improve on energy efficiency resulting in the reduction of operating costs?
- ▲ How to improve on the indoor environment for the occupants – Indoor Air Quality (IAQ), health, comfort, security?
- ▲ How to select durable and sustainable building materials?

One of the main questions to be answered: Is the goal or scope of the project achieving sustainability and high performance? Is increased initial capital cost possible; understanding that, the life cycle and operational cost savings will compensate or surpass for those capital costs by escalating the payback period and provide ongoing savings.

Utilizing analytical tools for Life Cycle Assessment (LCA) of the materials and building, plus a financial assessment with Life Cycle Cost (LCC) creates a solid fact-based profile for the life span of a building.

The ICFMA welcomes using or referencing these analytical tools to assess the value of ICFs for any design. The only caveat is that the true characteristics and values for an ICF wall assembly be utilized in any assessment. Noting, some assessment tools do not recognize all the contributions an ICF provides to the overall building envelope and operations of the building as a system –

- ▲ Recycled content of an ICF, approximately 40% by weight per block
- ▲ Whole wall thermal resistance values
- ▲ Overall energy savings on heating and cooling, saving on fossil fuels
- ▲ Continuous insulation
- ▲ Thermal mass

- ▲ High performance reduction of air infiltration from the continuous concrete
- ▲ Health contributions – mold resistance, does not rot or degrade, reduced allergens and dust
- ▲ Control of indoor air quality
- ▲ Security and resiliency
- ▲ Recyclable products – EPS, concrete and rebar

Insulating Concrete Forms are a key element in a sustainable design. The products provide a high energy performance wall assembly with high mass, high strength, and an extremely durable building envelope, keeping occupants healthy, comfortable and secure, plus being environmentally friendly.



Building practices that have the vision to promote sustainability in building design are creating a healthier environment, not only for the occupants, but the world.

4.1 Life Cycle Savings

The term 'life cycle' is a measurable assessment on the environmental performance of the overall building, and in all cases, performance is equated to dollar savings for the life of the building. In this type of analytical assessment, as an LCA or LCC, one has to compare the results to a 'mean value' or a comparative wall system. In most cases ICF construction has been compared to wood frame construction. There is an extensive list of detailed LCA reports that identify high percentage dollar and environmental savings over various time-lines, plus Global Warming Potential (GWP) savings for ICFs over other wall construction systems. These reports explore buildings in various climate zones, hot and cold, and all arrive at the same conclusions. **The characteristics, high performance values and durability of an ICF wall assembly outperform other wall assemblies.**

ICFs have been well documented to provide 20% to 40% savings in the operational phase of commercial multi-storey buildings due to energy (heating and cooling) savings, which is a

sustainable attribute for the life cycle of the building.

In a life cycle analysis, wood framing to an ICF wall assembly has a lower intensity for GHG, GWP and CO₂ emissions. This is substantiated by a report by the NRMCA – Publication NO. 2PCO₂ – Concrete CO₂ Fact Sheet – 2008), that details the advantages of concrete over other building materials for CO₂ emissions.

Numerous LCA reports have been completed and posted, comparing ICF construction to other construction materials and assemblies. Each of these reports arrives at the same positive conclusions, in favor of ICFs, for a number of reasons:

1. The initial embodied energy and carbon emissions for concrete in the ICFs is recognized to be higher than a wood frame wall, but in review of the life cycle performance and GHG emissions of the ICF building envelope, over 75 to 100 years, the energy savings of the ICF assembly compensates for the initial carbon emissions. Plus, in review, the wood frame building envelope degenerates over time, while the ICF building envelope remains stable.
2. The initial capital costs for ICFs, in commercial applications 'first cost' may be the same or lower than a wood or steel stud framed wall assembly, (refer to apples analogy Section 1.2.3 Material Comparison) but the additional thermal protection and reduction in air infiltration contribute substantially to energy savings that dramatically reduce the capital investment payback rate, plus provide annual net operating cost savings for the life of the building.
3. The durability, resiliency and sustainability of an ICF building envelope provides optimal performance over other wall assemblies, in a 100 year, life cycle analysis.

The following LCA reports on ICFs and concrete are available online for review:

- ▲ **Methods, Impacts, & Opportunities in Concrete Building Life Cycle – 2011**
MIT Concrete Sustainability Hub
John Ochsendorf
- ▲ **Comparative Life-Cycle Performance of ICFs vs Wood Framed Constructions – 2014**
BC Institute of Technology
Julien Schwartx, M.Eng
- ▲ **Concrete Sustainability and Life Cycle**
Portland Cement Association – 2007
- ▲ **LCA of an Insulating Concrete Form House Compared to a Wood Frame House – 2008**
Medgar L. Marceau and Martha G. VanGeem

4.2 Sustainability Programs

There are many sustainability programs available to assess the overall project design. These are very comprehensive programs seeking to reduce the negative impact the overall project will have on the environment, health and comfort of the habitat space. The basic goal for sustainability is to improve the performance of materials and the building systems, plus reduce the consumption of non-renewable resources.

In most of these assessment programs there are a number of aspects that do not apply to an ICF product or design, such as water conservation, site optimization, transportation or building orientation. As well in these programs, there are other elements that are benefits from an ICF wall assembly that previously may not have existed, or in some programs may not be recognized as contributing points, such as – thermal mass, air tightness, acoustic control, security, durability and health issues related to mold resistance and IAQ.

The CaGBC and USGBC program LEED v4 is the benchmark for the assessment of sustainability. Both Councils recognize ICFs as a 'green and innovative' building product. As the LEED program has evolved, to the newest version 4.0, it has come to recognize more of these benefits available from the characteristics of an ICF and an ICF wall assembly.

ICF projects have a long history, for many building types, of being evaluated and certified in the LEED program. In reviewing the Case Studies there are number of buildings that have a 'Platinum' rating. ICF contribute points to number of categories in the LEED rating system:

- ▲ Energy & Atmosphere – minimizing energy use, optimizing energy performance
- ▲ Materials & Resources – construction waste, recycled material content, regional materials
- ▲ Indoor Environmental Quality – indoor air quality, thermal comfort
- ▲ Innovation & Design – reduction of HVAC system, mold resistant, energy savings, sound attenuation

The many characteristics and benefits provided by an ICF, as a building material and a wall assembly, appeal to more than 40% of the design requirements in a LEED rating assessment.

One of the biggest advantages from building with ICFs, is the operational energy savings. This has been recognized by electrical and gas companies across North America. These companies have developed sustainability incentive programs that reward high performance projects with financial rebates.

Integrating an ICF into the design strategy will enhance the appraised value for any sustainability program. Now, in the marketplace, there is more recognition and evaluation conducted by insurance, property appraisal and financial companies to promote sustainability, durability and high performance buildings. These assessment programs are looking to minimize risk and improve the investment value.

Some of the programs that identify the benefits of an Insulating Concrete Form building shell:

- ▲ LEED v4 (CaGBC or USGBC)
- ▲ BCIP (Canada)
- ▲ FORTIFIED™: Resilience Standard for Insurance Incentives
- ▲ Energy Star®
- ▲ Zero Energy Ready (US)
- ▲ Green Globes
- ▲ BuiltGreen® (Canada)
- ▲ R-2000 (Canada)

4.3 Economical Feasibility Factors

'As a rule of thumb, building with the lowest construction costs require higher maintenance and higher energy inputs over the buildings lifespan.'

ICF Builder Magazine – ICFs and the Life-Cycle Assessment 2015



What are the factors to consider or assess for economical feasibility? Depending on which 'hat' you wear in the design, construction or ownership of the building, these factors impact each differentially as part of their strategic goal to make the project a success. To address this topic, just consider some of the key feasibility factors ICFs and an ICF building will provide toward the economics of a multi-storey design:

CONSTRUCTION SPEED – the installation of ICF walls and the concrete is very fast, expediting the completion of the building shell and making the building weather tight. This allows other sub-trades such as mechanical, electrical and wall finishers to accelerate their installation schedule.

EXTENDED CONSTRUCTION SEASON – construction is not influenced by cold or hot weather, ICFs and concrete can be installed 12 months of the year, in all climate zones.

CONSTRUCTION FINANCING – expedited construction time-lines assist in reducing construction financing costs.

FEWER BUILDING ENVELOPE MATERIALS – an ICF eliminates the requirement for a vapor barrier, air barrier, additional insulation to reduce thermal bridging, wall strapping/furring for finishes and additional caulking.

FEWER SUB-TRADES – because ICFs eliminate specific materials required on the building envelope and includes some materials that are now part of the ICF installers scope, numerous sub-trades are not required.

REDUCE CONSTRUCTION WASTE AND INCREASE SAFETY – the modular product reduces waste on the job-site, provide a clean work site promoting job site safety. Both of these attributes alleviate costs for landfill dumping and workman compensation claims.

HVAC EQUIPMENT DESIGN AND OPERATION – the high performance walls with very low air infiltration allows for the overall reduction in the design of HVAC equipment. Also the energy efficiency reduces maintenance and working loads on the equipment, improving the life span of the equipment.

REDUCED INSURANCE COSTS – this applies to the construction phase as well as in consideration for the completed building being classified as a Resilient Building, reducing risk and damages. On going savings for buildings life cycle.

RESILIENCY AND DURABILITY – in addition to insurance savings, fewer construction deficiencies, less building maintenance and increased durability from weather related events. ICFs eliminate damage to the wall system during construction from rain and moisture penetration.

OPERATIONAL COST SAVINGS – the high performance walls improve the efficiency of the HVAC systems and provide substantial (20% to 40%) utility cost savings – heating and cooling for the life of the building. These cost savings occur daily/monthly continuously for the life of the building.

COMPLIMENTARY ENVELOPE FOR ALTERNATIVE ENERGY SYSTEMS – an ICF, high performance building envelope, compliments the design and installation of alternative energy systems – solar, wind, and geothermal.

REAL ESTATE ASSESSMENT VALUES – the characteristics that are provided from an ICF building, especially resiliency, durability, sustainability and comfort improve the assessment values of the building and make it attractive as an investment. The added durability and resiliency stabilizes the depreciation rate of the building.

CAPITALIZATION RATE – an evaluation rate comparing buildings for investment. The ICF advantage is the ratio between the initial capital costs and the net operating costs. Since the operating costs for an ICF building will be substantially lower than other conventional construction buildings, this rate will become advantageous in any assessment.

HIGHER RENTAL RATES – since the interior space is energy efficient, comfortable with great indoor air quality, sound attenuation, and security the building owner can expect to receive a higher rental rate.

OCCUPANCY TIME-LINE – In addition to all of these savings and advantages the biggest economic benefit building with ICFs is the advancement of the occupancy schedule. The enhancement provided in construction speed, which can be measured in months, advances the buildings completion and occupancy date. ICFs have proven, over and over, that accelerated occupancy time lines are achievable. This satisfies everyone's goal, expediting the generation of rental income and moving occupants into the new space.

In addition to all of these economic benefits for the construction and building, there is one more tangible advantage to building with ICFs – **MARKETING**. The developer, designer and contractor will be able to market their companies as a high performance, sustainability 'green' builder. The marketing for the building may also be focused on the environmentally friendly clients, promoting a high efficiency and sustainable lifestyle.

There are many economic factors that are feasible with ICF construction that would not be possible with conventional construction. Saving time and money are the key goals for every project. Having the ability, by using one specific build material – ICFs, to provide these advantages, be sustainable, plus advance the completion date and occupancy dates, is remarkable.

Review the Case Studies in this guide, identifying and verifying some of these benefits.

5.0 Structural/Engineering Design

The insulating concrete form was originally developed for residential applications - below grade foundation walls and above grade walls. Following standard engineering design principles for reinforced concrete, prescriptive engineering tables were developed to meet the building code requirements for residential and light construction buildings. Over the last ten years, designers and engineers have enthusiastically realized that an ICF is indeed a beneficial forming system for reinforced concrete buildings and may be used to design tall walls and multi-storey buildings. This has led to an explosion in the commercial market for projects such as big box stores and industrial buildings with walls over 32' (9.75m) high between lateral supports and multi-storey residential buildings over 25 stories with ICF walls as the load bearing structural shell.

Multi-storey applications, depending on the height and engineering, may utilize the versatility of the concrete core sizes of the ICF to transition the concrete core size from 12" to 6" (305mm to 150mm) at various floor levels, as the building rises. The characteristics of the ICF are not only advantageous for structural design by keeping the reinforced concrete enclosed between layers of rigid EPS insulation but provide sustainability and resiliency to the building envelope.

ICFMA member companies, provide a code approved concrete forming system that meets exact testing criteria to resist the hydrostatic pressure of the liquid concrete, during placement and consolidation, following manufacturers' installation specifications. It is also a proven fact that the concrete within an ICF, because it retains more moisture during the curing process, develops a very high early strength and a sustained strength for the life of the wall system.

The structural design and engineering for the reinforced concrete walls within an ICF can meet all the requirements for vertical and lateral loads, point loads, wind loads and seismic loads in most instances with minimal reinforcement bar sizes and configurations. The design considerations for utilizing ICFs for multi-storey buildings, require the typical application of reinforced concrete design principles. The versatility with ICFs allows each wall, in the design, to have the mass and reinforcement to accommodate the specific forces and loads. This design ability conveys materials and labor cost savings for the project.

ICFs and concrete present tremendous advantages for the engineering design team considering the elements for constructibility, sustainability, resiliency, and life-cycle of a multi-storey structure.

5.1 Structural Design Standards

Reinforced concrete design and engineering in Canada follows - CAN/CSA A23.3 Design of Concrete Structures and in the United States follows - ACI 318 – Building Code Requirements for Structural Concrete, American Concrete Institute.



Notably, reinforced concrete is one of the strongest structural systems for walls. Designing a reinforced concrete wall that spans vertically between lateral supports allows for a thinner concrete wall design as detailed in the structural design criteria. Depending on the project design requirements, some multi-storey buildings up to five storeys have been constructed with

a 6" (150mm) concrete core ICF. Other projects, such as box big stores with 32' (9.75M) high tall walls have been constructed using an 8" (200mm) ICF.

The load bearing capacity for ICF walls can support any type of floor or roof system. For large multi-storey buildings ICF walls may be designed as shear walls, elevator shafts, and interior load bearing walls.

There is a simplicity with the design and installation of an ICF wall system - the insulating form, the reinforcement and the concrete working together as one in the structural building envelope.

5.2 Concrete and Reinforcement Specifications

5.2.1 Concrete

The ready mixed concrete industry has developed ICF mix designs to suit the ICF manufacturers' specific applications. The concrete design strength for an ICF does not have to be increased due to this innovative forming system. A minimum design compressive strength of 3000 psi (20MPa) after 28 days is typical. The strength will be specified by the Engineer of Record to suit the project.

Concrete specifications for ICFs have two main requirements that are important to the placement and flow of concrete within the forms:

Slump – recommended concrete slump for commercial work shall be a minimum of 5" to 6" (102mm to 152mm) (subject to climate and engineering design). This higher slump allows the concrete to flow easily within the forms and prevents damage to the cross-ties during placement. Slump verification by testing upon delivery is recommended. In some instances higher concentrations of reinforcement may dictate higher slump than this minimum.

Aggregate size – a smaller aggregate size is recommended to alleviate congestion in the walls between the reinforcement bars and the inside face of the ICF. A smaller aggregate also improves the flow rate within the forms. The recommended aggregate size for a 6" (150mm) ICF core size is either 3/8" to 1/2" (9.5 to 12.5mm) and for larger ICF forms with 8" (200mm) and higher core sizes a 1/2" to 3/4" (12.5 to 19mm) may be used.

Concrete placement is typically done from a pump truck or line pump. The placement rate is controlled and regulated by multiple lift heights, minimizing the hydrostatic pressure within the forms. All ICF wall applications are required to be consolidated by an internal vibrator. Typically, concrete is placed and consolidated in the ICF walls from floor level to floor level as a continuous pour in lifts of 4' (1220mm).

The NRMCA is developing a program to promote an Environmental Product Declaration (EPD) for ready mix and concrete producers, to meet the requirements of LEED v4 in the production and mix designs of concrete. The use of supplementary cementing materials (SCM) such as Fly Ash or Slag Cement as recycled materials is recognized as an advantage for an environmental assessment and is acceptable for use with an ICF.

The EPS insulation layers provide five major advantages for the monolithic concrete core:

1. The concrete is never exposed to the weather and therefore retains a higher moisture content, a slow cure that results in a high early strength and longevity.

2. By not being exposed to the weather and having the concrete insulated, the requirement for expansion or control joints is eliminated, on most walls.
3. The insulation layers allow for concrete placement in cold weather or basically year round, extending the building season.
4. During the hydration process the concrete generates heat which remains in the insulated wall as it cures. This eliminates supplement heating and hoarding (sealing the building & heating to work) during the winter months.
5. The insulated mass of concrete provides a 'thermal lag' in the temperature change through the wall system which enhances the overall energy performance of the wall assembly.

In the design phase of selecting materials for the multi-storey walls there are a number of key functions that the building envelope materials must have the ability to provide and sustain for years. In comparison to conventional construction materials, the concrete alone in an ICF wall assembly excels in providing the following key assets:

- ▲ Structural strength and resiliency
- ▲ Fire resistance
- ▲ Continuous air barrier
- ▲ Durability and longevity
- ▲ Will not rot or deteriorate
- ▲ Not a food source for mold
- ▲ Thermal mass
- ▲ Speed of construction for the project to be weather tight
- ▲ Minimizing waste in the construction of the building envelope
- ▲ Life cycle cost savings
- ▲ Environmental assessment advantages (LEED v4)

5.2.2 Reinforcement

ICF forms are designed with cross ties (webs) molded into the EPS panels. These cross-ties webs) have evenly spaced notches or seats, to accept the placement of horizontal reinforcement bars. Typical horizontal and vertical reinforcement bar sizes for an ICF wall may be 10M, 15M or 20M (#4, #5, #6) bars. Larger forms accommodate #7 (25M) and #8 (30M) bar sizes. The Project Engineer will follow standard structural concrete design criteria for thin walls to develop the size and layout of the reinforcement. For ICFs the layout of the horizontal reinforcement is recommended to be compatible with the specific ICF form height, which could provide a horizontal spacing at 12", 16", 18" or 24" (300mm, 400mm, 460mm or 610mm) on center.

Placement for reinforcing bars in ICFs follows the structural design criteria for a non-contact lap splice method which reduces installation time by minimizing the tying of rebar.

Primary reinforcement is recommended to be deformed steel with minimum yield strength of 60 KSI (423MPa) per ASTM A615 - Standard Specification for Deformed Steel Concrete



Reinforcement. However, Below grade reinforcement is typically placed closer to tensile side of wall which is the inside face of concrete. Above grade reinforcement is often centered in wall due to balanced negative and positive wind pressure.

Since the concrete in an ICF is protected from the earth and the weather by layers of EPS insulation, the reinforcement bars may be placed closer to the outside face of the concrete. A minimum of $\frac{3}{4}$ " (19mm) concrete coverage is required in an ICF (ACI 318).

ICFs can accommodate the reinforcement design for beams and lintels over openings. This design would involve stirrups and extra horizontal rebar to form the structural component as a beam or lintel. ICFs also have the ability to be configured and designed, as in wall columns or pilasters. The use of structural hangers and other embedments in the concrete are easily accommodated in an ICF and additional reinforcement can be inserted in the wall for point loads.

In order to accommodate extreme loading from high winds and seismic events, the reinforcement layout may be designed as a double mat, with bars spaced vertically and horizontally, along the inside and outside within the concrete. The ICFMA is cooperating with other companies in the use and development of engineering standards for concrete fiber reinforcing for use in ICFs. There has been considerable interest in the cost and time savings attributed to the use of steel or synthetic fiber concrete reinforcing products. Although fiber reinforcing does not eliminate all the bar reinforcement in the ICF walls, it does save a large percentage on time and material, plus provides additional structural stability.

5.3 Resilient Design

There is a very strong and active collaboration of high profile associations pushing forward the need, in today's building markets, for resilient design. These associations, such as NRMCA, PCA, ACI, CGBC, USGBC and others, all recognize the impact of climate change, weather related events and natural disasters on structures and human life. Building and designing to minimum code standards in these high risk areas must change.

The key associations mentioned above that are involved in the resilient design movement are related to concrete and sustainability. Concrete, for ages, has proven itself a durable product with the longevity to be around for centuries. Concrete has durability, longevity and is a resilient and sustainable building product.

The inherent properties of engineered reinforced concrete walls within an ICF can resist high winds, floods, storm surges, fire and seismic events. Additionally, the walls will not rot, promote mold or mildew growth and the EPS layers protect the concrete from high impact explosions.

The Insurance Institute for Business and Home Safety and the Fortified program recognize ICF construction as a sustainable answer to a resilient design solution. The very high cost in property damage and total destruction of homes and buildings is forcing the conventional design standards to change. Climate change has expanded the risk areas triggering building owners and insurance companies to move to a more viable solution to mitigate the catastrophic damage, insured losses and re-building costs.

The paradox in these high risk areas is that for safety, conventionally constructed homes and buildings have FEMA approved safe rooms built with ICFs.

Structural Resistance (PCA Seismic Test)					
Wall Panel	(1) Global Lateral Stiffness (lbs/in) ¹	(2) Load at First Major Damage (lbs)	(3) Displacement at First Major Damage (in)	(4) Maximum Lateral Resistance (lbs)	(5) Displacement at Maximum Lateral Resistance (in)
Wood Frame	18,500	3,500	0.51	4,553	0.89
Steel Frame	30,000	3,500	0.54	4,004	0.76
ICF Flat	708,000	8,500	0.06	34,245	2.66

1. ICF stiffness - **24x stiffer**
2. Takes more than **2x the pressure** to cause damage
3. First damage - **90% less damage** than other materials
4. Max resistance - **10x the resistance** compared to others
5. When max displacement is reached ICFs can **bend/move 3x more** before failure

The ICFMA with the NRMCA and other groups are spearheading ICF design and construction as the experienced solution for resiliency in design. Homes and buildings utilizing a design strategy of incorporating ICFs and reinforced concrete for durability, sustainability and resiliency are being acknowledged and rewarded by insurance companies and environmental assessment agencies.

Design teams should adhere to this definition from the Resilient Design Institute:

“Durability strengthens resilience. Strategies that increase durability enhance resilience. Durability involves not only building practices, but also building design, infrastructure, and ecosystems.”

Designing and building with ICFs provides durability and strengthens the resiliency of the structure and the human environment.

6.0 Code Standards & Testing

Insulating concrete forms were introduced to North America in the 1960's and as a building product, were not covered in any building codes. ICFs were considered to be an 'innovative product'. Over the years, building code agencies and the ICF industry, in a collaborative effort, have incorporated ICFs into the model codes. This intensive development process has created product, manufacturing and application standards through recognized third party testing laboratories, code evaluation and inspection agencies, plus design and engineering professionals. The goal of this collective driven effort has been to elevate the quality and standards to the highest level, not only for the products and applications, but the entire industry as a whole.

The ICFMA is continually addressing the applications, detailing and installation procedures for ICFs with recognized third parties, engineers, construction professionals and testing laboratories. This practice has led to the recognition of insulating concrete forms as a sustainable, energy efficient and viable building material, and is still recognized as an innovative construction system.

The design integration of ICFs with a variety of structural systems, such as precast and concrete metal deck - OWSJ floor systems, plus compatibility for the application of all types of wall finishing materials, interior and exterior, has confidently and successfully moved the ICF industry into the multi-storey and commercial marketplace for all building types and sizes.

Developers and Architects want to design and construct better buildings. The integrated development for structural design, testing and detailing required to meet and exceed minimum code requirements in North America has been successfully achieved, documented and proven by the ICF industry. Designing and building with an ICF presents many exceptional benefits that have all been verified by testing and endorsed by codes and standards agencies.

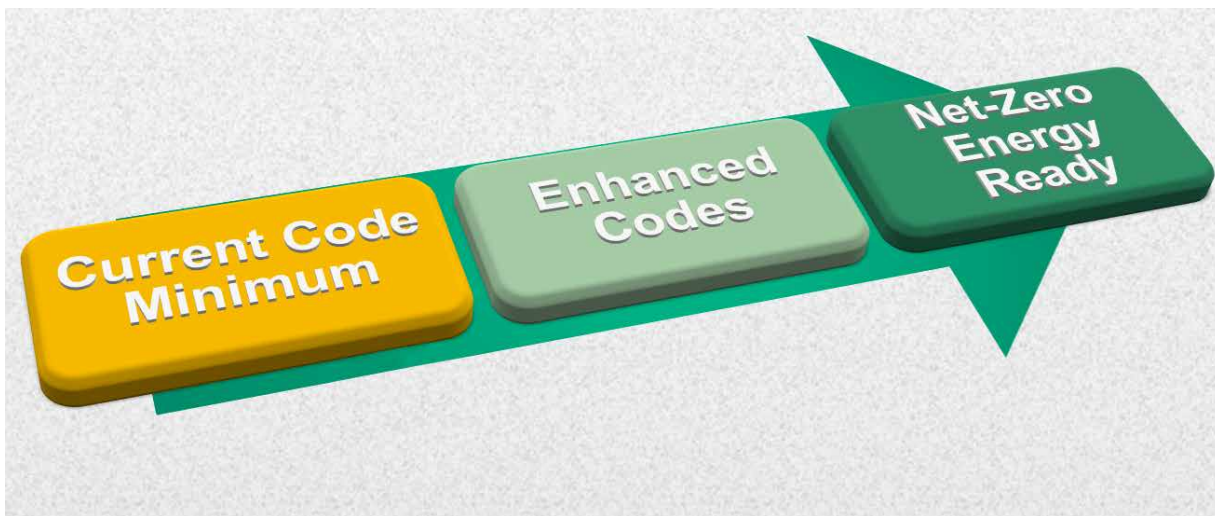

6.1 Building Codes (NBCC & ICC - IBC & IRC)

A principle part of the development of the ICF industry is the involvement of the building code and evaluation agencies: the CCMC in Canada and the International Code Council in the USA. As an 'innovative product' inclusion in the building codes required all aspects of the concrete forming system and the plastic insulation (expanded polystyrene) to be extensively reviewed, tested and approved. This verification has established the confidence, through research and testing, to list ICFs in all the model building codes – NBCC, IBC and IRC. Both Canada and USA have developed specific evaluation and testing criteria and require ICF companies and their products to be approved and compliant to these standards.

The inclusion of ICFs in the building codes pertains mostly to above and below grade residential and light commercial wall construction. ICFs, as a reinforced concrete wall system, have the structural capacity to exceed code requirements for these building types. A typical ICF wall design may result in thinner reinforced concrete walls, following standard product prescriptive engineering tables or reinforced concrete designs per CAN/CSA A23.3 or ACI 318. This code compliant, thinner reinforced concrete structural wall design, utilizing ICFs, provides a material and labor cost savings for all projects.

Multi-storey and larger commercial projects exceeding the residential code requirements for size and height within NBCC Part 9 or IRC Section R404 and R611, will follow code requirements for concrete design and standard engineering principles applicable for reinforced concrete walls, utilizing the most current version for reinforced concrete design per – CAN/CSA A23.3 or ACI 318.

The model building codes also address and require approval, upon third party testing, of the materials and assembly applications of ICFs. The results of which recognize the inherent characteristics and advantages of insulating concrete forms as a wall assembly, such as:

- ▲ Plastic insulation and cross-ties (webs) – thermal protection, ignition, fire and smoke requirements
- ▲ Thermal transmission
- ▲ Air, vapor and moisture infiltration
- ▲ Fire resistance rated wall assemblies
- ▲ Attachment of finishes to the cross-ties (webs) and the EPS substrate
- ▲ Sound attenuation
- ▲ Waterproofing applications – below grade



Each ICF product and manufacturing facility must be evaluated and approved to meet specific building code 'Acceptance Standards'. An approved evaluation report, for Canada and the USA, on code compliance for the products and manufacturing is required and will be posted on the ICFMA manufacturers' website.

These reports are developed by code evaluation services or code recognized testing laboratories. Both in Canada and the USA, building code evaluation reports must be renewed and kept up-to-date with code revisions and updates to the acceptance criteria and standards.

Design ICFs with Known Canadian Standards

	<p>National Building Code of Canada</p> <ul style="list-style-type: none"> • or Provincial Building Codes • Parts 4 & 9 • Post-Disaster Category
	<p>National Energy Code of Canada 2011</p> <ul style="list-style-type: none"> • Thermal Requirements for Buildings
	<p>CAN/CSA A23.3</p> <ul style="list-style-type: none"> • Design of Concrete Structures
	<p>ASCE 24-05</p> <ul style="list-style-type: none"> • Flood Resistant Design & Construction

Design ICFs with Known US Standards

	<p>International Code Council</p> <ul style="list-style-type: none"> • International Residential Code • Chapters 3, 4, 6 & 10
	<p>International Code Council</p> <ul style="list-style-type: none"> • International Residential Code • Chapters 16 & 19
	<p>International Code Council</p> <ul style="list-style-type: none"> • International Energy Conservation Code

	<p>ACI 318</p> <ul style="list-style-type: none"> • Building Requirements for Structural Concrete
	<p>ASCE 24-05</p> <ul style="list-style-type: none"> • Flood Resistant Design & Construction

6.2 Acceptance Criteria and ICF Standards

Building code agencies in Canada and the USA have created 'Acceptance Criteria and Standards' to provide guidelines for the evaluation of the ICF material properties and manufacturing compliance standards. Also set forth are structural and construction design provisions for flat wall ICFs, that meet the building code for all building types of any height. In addition, all manufacturing facilities must be inspected on a regular basis, by a third party agency, to ensure the manufacturing and product quality control meets these specifications.

The ICF criteria for Canada was developed in collaboration with the ICF industry and the CCMC.

▲ *Technical Guide for the Evaluation of Modular Expanded-Polystyrene Concrete Forms.*

Similarly, the ICC-Evaluation Services has the following acceptance criteria:

▲ **AC308 - Acceptance Criteria for Stay-in-Place Foam Plastic Insulation Concrete Form Systems for Solid Concrete Walls**

In addition to these manufacturing and product standards, the ICF industry has developed in collaboration with ULC and ASTM, specific standards for flat wall ICF systems. These are stand-alone documents that are to be incorporated into the model building codes.

▲ **CAN/ULC S717.1: Standard for Flat Wall Insulating Concrete Form (ICF) Systems**

▲ **ASTM E2634: Standard Specification for Flat Wall ICF Systems**

This commitment by the ICFMA, in association with the code agencies and these recognized standards/testing agencies, provides any design team with the assurance that these products over achieve minimum building code and that the quality control standards for manufacturing is well monitored.

6.3 Testing



The acceptance criteria and ICF standards identify an extensive array of test criteria that addresses all applications and performance characteristics for plastic insulation, plastic ties and the structural capacity of an ICF as a forming system. In selecting a building product, for any building type and height, the design team, owner and developer should be very comfortable with ICFs due to the evaluation and approvals process that the product must adhere to.

The ICFMA is continually working with laboratories and institute testing to ensure the applications and performance of ICFs exceeds building and energy code standards. Some of the main areas where ICFs excel and qualified testing reports to verify these performance advantages are being developed or have been developed:

- ▲ High resistance to air and moisture infiltration
- ▲ Indoor Air Quality (IAQ) , measurable health and comfort benefits
- ▲ Evaluation of energy performance provided by 'thermal lag' from mass concrete walls within an ICF
- ▲ Evaluation of how the whole wall assembly performs for thermal resistance for energy cost savings

- ▲ ICF building envelope modeling and design criteria for reduction on HVAC equipment
- ▲ Revisions and/or additional data for Manual J and ASHRAE 90.1 calculation programs
- ▲ Life cycle cost savings, capitalization rate
- ▲ Resilient structural design

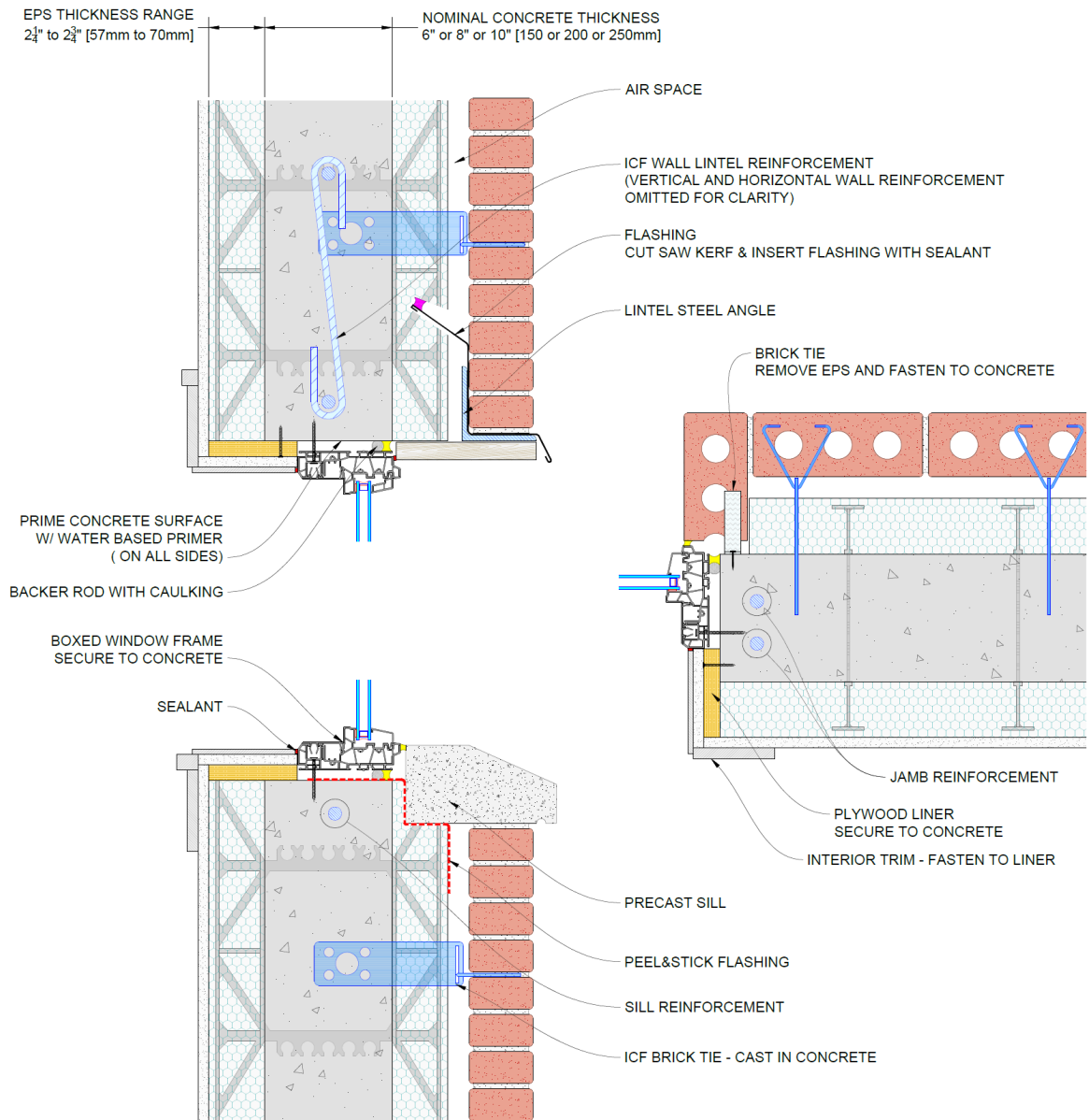

The following is a listing of some the testing and/or standards required by the code agencies and the ICF industry:

Canadian Standards Association (CSA)

- ▲ CAN/CSA A23.1 Concrete Materials and Methods of Concrete Construction
- ▲ CAN/CSA A23.3 Design of Concrete Structures

Underwriters Laboratories of Canada Inc. (ULC)

- ▲ CAN/ULC S717.1: Standard for Flat Wall Insulating Concrete Form (ICF) Systems
- ▲ CAN/ULC S101: Standard Methods of Fire Endurance Tests of Building Construction and Materials
- ▲ CAN/ULC S102: Method of Test for Surface Burning Characteristics of Building Materials and Assemblies
- ▲ CAN4-S124-M: Test for the Evaluation of Protective Coverings for Foam Plastic
- ▲ CAN/ULC S-134: Fire Testing of Exterior Wall Assemblies
- ▲ CAN/ULC S701: Standard for Thermal Insulation, Polystyrene, Boards and Pipe Covering

American Society for Testing and Materials (ASTM)

- ▲ ASTM E2634: Standard Specifications for Flat Wall ICF Systems
- ▲ ASTM C165: Standard Test Method for Measuring Compressive Properties of Thermal Insulations
- ▲ ASTM C177: Standard Test Method for Steady-State Heat Flux Measurements and Thermal Transmission Properties by Means of the Guarded-Hot-Plate Apparatus
- ▲ ASTM C203: Standard Test Methods for Breaking Load and Flexural Properties of Block-Type Thermal Insulation
- ▲ ASTM C303: Standard Test Method for Dimensions and Density of Preformed Block and Board-Type Thermal Insulation
- ▲ ASTM C518: Standard Test Method for Steady-State Thermal Transmission Properties by Means of the Heat Flow Meter Apparatus
- ▲ ASTM D578: Specification for Rigid Cellular Polystyrene Thermal Insulation
- ▲ ASTM D1621: Standard Test Method for Compressive Properties of Rigid Cellular Plastics
- ▲ ASTM D1761: Test Procedures for Lateral and Withdrawal Load Strength of Fasteners into Cross-ties (webs)
- ▲ ASTM D1929: Standard Test Methods Ignition Properties of Plastics
- ▲ ASTM D2126: Standard Test Method for Response of Rigid Cellular Plastics to Thermal and Humid Aging
- ▲ ASTM D2863: Standard Test Method for Measuring the Minimum Oxygen Concentration to Support Candle-Like Combustion of Plastics (Oxygen Index)
- ▲ ASTM E84: Surface Burning Characteristics- Smoke and Flame

- ▲ ASTM E90: Standard Test Method for Laboratory Measurement of Airborne Sound Transmission Loss of Building Partitions and Elements
- ▲ ASTM E96: Standard Test Methods for Water Vapor Transmission of Materials
- ▲ ASTM E119: Standard Testing for Fire Resistant Wall Assemblies
- ▲ ASTM E336: Standard Test Method for Measurement of Airborne Sound Attenuation between Rooms in Buildings.

Other Agencies:

- ▲ NFPA 286: Method of Fire Test Contribution of Wall and Ceiling Interior Finish to Room Fire Growth
- ▲ UL 263: Standard fire Tests of Building Construction Materials
- ▲ UL 723: Standard for Test of Surface Burning Characteristics of Building Materials
- ▲ UL 1715: Standard fire Test for Interior Finishes
- ▲ UBC Standard 26-3: Room fire Test for Interior of Foam Plastic Systems
- ▲ ACI 318: Building Code Requirements for Structural Concrete
- ▲ PCA 100: Prescriptive Design of Exterior Concrete Walls – Residential

6.4 Specifications

The MasterFormat specifications for Canada (CSC) and the USA (CSI) have indexed Insulating Concrete Forming under the Concrete Forming section in Division 03 11 19. Refer to an ICFMA listed manufacturers' website for a typical layout of a Division 03 11 19 standard specification for ICFs.

The specification should request, that for project acceptance, an ICF company be a member in good standing with the ICFMA and have an approved code compliance evaluation report.

One of the unique characteristics of an ICF installation, that needs to be recognized in the specifications, is the multi-tasking functions available through the use of an insulating concrete form by the ICF contractor/ installer. This contractor/installer places the ICF, places the rebar and executes the concrete placement and consolidation within the wall system. Also with the ICF, the insulation, air barrier, vapor barrier and finishes substrate and fastening strips are all installed as part of the ICF, basically by one contractor.

Multi-storey projects should specify that the ICF installer have a minimum of five years of experience working with the product, plus have completed installation training by the specified ICF manufacturer. The specification should also consider any required ICF accessory products, to compliment the ICF forms. Most ICF companies supply or manufacturer accessory products that are specifically designed for their ICF applications.

As part of the Design Team, your research on an ICF products will reveal that even though ICFs are a modular product, the size of the actual blocks, per ICF companies, may differ in height and or length. In designing and specifying an ICF this factor should be considered.

The extensive testing required to meet the code evaluation report will provide the specification with adequate Reference Standards. If fire resistance rated wall assemblies are required, ensure the manufacturer has the required testing by a recognized laboratory.

6.5 Energy Codes (NECC and IECC)

Over the last few years, energy codes (NECC and IECC) have been more aggressive in raising the standards in all climate zones. They have also recognized numerous flaws in conventional construction and addressed them in the energy codes by requiring more materials – air barriers, exterior insulation to combat thermal bridging and sealing for air and moisture infiltration. **These code upgrades have substantially increased the material and labor costs for conventional construction.**

The performance characteristics of a simple ICF wall assembly has been out performing the NECC and IECC code requirements for many years and still is surpassing even more stringent standards.

The energy codes now have recognized and incorporated into the code a number of major factors with respect to energy efficiency that directly relate to the performance characteristics of ICFs:

- ▲ Performance of the whole wall assembly
- ▲ Energy efficiency provided by less air infiltration
- ▲ Advantages of mass walls – concrete

These elements are all detailed in the energy codes and have direct references to ICF wall assemblies. The codes now recognized 'mass walls' and/or 'ICF walls' and show specific performance requirements that are generally less than a conventional wall assembly.

The major performance advantages for ICFs with respect to energy efficiency, do not require additional materials or labor in the wall assembly. These are the inherent properties of product:

- ▲ Continuous, two layers of rigid expanded polystyrene insulation
- ▲ Continuous mass concrete as the building envelope
- ▲ Continuous air barrier
- ▲ Continuous vapor barrier
- ▲ No thermal bridging

Desired Characteristics of Building Shells				
Desired Characteristics **Code Mandated	Wood Frame	Steel Frame	Conventional Concrete	ICF & Concrete
Moisture Resistant**	↓	\$\$	Yes	Yes
Wind Resistant**	\$\$	\$	Yes	Yes
Seismic Resistant**	\$\$	\$	Yes	Yes
Thermal Continuity**	\$	\$\$	\$\$	Yes
Fire Resistant**	↓	\$\$	Yes	Yes
Safe/Non-Toxic**	Yes	Yes	Yes	Yes
Impact Resistant	↓	↓	Yes	Yes
Adaptable to Design Utilities	\$	\$\$	\$\$	Yes

This combination of performance characteristics, for a 6" (150mm) concrete core wall assembly provides a continuous thermal transmission rate of R22.76 (RSI 4.01, U value 0.249). This exceeds the requirements most climate zones for above and below grade walls.

Some energy modeling programs may need to be adjusted as they may not recognize the true performance characteristics of an ICF wall assembly, specifically the whole wall assembly thermal rating and the very low air infiltration rate. Manual J and ASHRAE 90.1 have areas that allow for these ICF attributes.

Most ICFMA companies have products or accessories to enhance the thermal resistance performance for the extreme climate zones or the energy conscience client.

As the energy code standards increase, the concept of a whole wall assembly performance has taken over the marketplace. The simplicity of an insulating form with a mass concrete core functioning as a high performance, energy efficient wall assembly is a fantastically viable option for any multi-storey or commercial building. Especially, for developers and building owners that realize the opportunity for extraordinary net energy cost savings per year, every year for the life of the building.

7.0 Glossary of Abbreviations

The following is a listing of abbreviations of ICF, Building Enclosure and Thermal Control Terminology utilized throughout this design manual.

Term	Definition	Relationship & Significance to ICF Products
ACI	American Concrete Institute	ICFMA member firms have all designed their products to permit ease of designing using ACI criteria.
ACH	Air changes per hour	ICF/Concrete walls have been demonstrated to reduce uncontrolled air exchange in the building shell by 60%.
Air Barrier	A semi-impermeable layer placed on the building enclosure to control the movement of air into and out of the building.	ICF/Concrete walls are generally exempted by building codes from air barriers (like building paper and Tyvek) because of the impermeability of the concrete layer, which is the core of the ICF structure.
Air Exchange Rate	Number of instances (per hour) of 100% replacement of air contained within the building enclosure by outside air. Usually measured by means of blower door testing.	According to building science experts, unplanned air leakage is a bigger problem to building thermal performance than R-Value or U- Value. Solid concrete walls do not permit air to pass through (clear wall areas), and ICF walls have been shown (by CMHC studies) to reduce air infiltration through the building shell by 60%. Therefore, ICF walls make a significant contribution to controlling unplanned air exchange as well as easily providing the level of insulation value (R-value) that is appropriate to the climate zone.
ASHRAE	American Society of Heating, Refrigerating and Air-Conditioning Engineers	ICF walls/floors/roofs generally have higher impact on building thermal and air quality performance than any other component or building method. This will help customers meet or exceed the building standards (thermal insulation, indoor air quality, occupant comfort) offered by ASHRAE and building codes in a simple and cost-effective fashion.
ASTM	American Society for Testing and Materials	ICFMA member firms have all performed required testing under ASTM criteria
Bar	Deformed steel reinforcement bars	ICFs are reinforced with deformed steel reinforcement bars according to design principles offered in major code criteria, such as ACI and CAN/ULC.

Term	Definition	Relationship & Significance to ICF Products
Block	One insulating form unit (called a form or a block)	ICFs are typically of either a "block" or "panel" design.
Blower Door Test	A standardized test method to measure the rate of air exchange that can be expected due to leaks in the building enclosure which are not part of the planned air-exchange rate specified in the Energy Management Plan.	Due to the fact that solid concrete walls can significantly reduce the rate of unplanned air leakage in a building shell, ICF constructed buildings, by their very nature and without added cost, have a much higher level of air-tightness when subjected to a blower-door test, which is now becoming mandatory in many code jurisdictions world- wide.
Buck	The frame (wood, steel or EPS) around an opening in an ICF wall, that supports the concrete in the wall cavity and acts of the fastening substrate for the window or door	Laboratory and field testing has confirmed ICF "best-practices" for installation of windows & doors, whether using a permanent or removable bucking.
Building Enclosure	(Also: Building Envelope, Building Shell) The layer of wall, floor, and roof components in a building that separate interior spaces from the outside environment. Includes all structural and thermal control elements.	ICFs perform quadruple duty in the building enclosure, as they provide 1) a form for the concrete structure, 2) permanent insulation, 3) a chase for utilities, and 4) a stable substrate for interior and exterior finishes.
CAN	Canada	The National Building Code of Canada contains clear standards for ICFs and ICF/ concrete construction.
CCMC	Canadian Construction Materials Centre	Evaluation by CCMC is optional in Canada and is not required by code.
Cladding	Cladding refers to a material or component of the wall assembly which forms the outer surface of the wall and is exposed to the full force of the environment.	ICF/Concrete walls can be designed to accommodate nearly any exterior finish, including wood, plastic, or fiber-cement panelized cladding or lapped siding.
Clear Wall Area	A term used in building enclosure science to denote the contiguous area of wall which contains no windows, doors, corners, or elements other than the wall system in question. Examples are uninterrupted wood-stud, masonry, or ICF walls.	The "clear wall area" developed by ICFs offers more value in terms of structural strength, resistance to heat transfer, and resistance to air leakage (zero air porosity) than any competing wall construction.

Term	Definition	Relationship & Significance to ICF Products
Climate Zone	A geographical climate classification system designed for use in energy codes, design guidelines, and building energy analysis. Standard climate zones are usually found in national building codes, like I-Codes in USA and the NBCC in Canada. Energy code requirements will differ from zone to zone, depending on climatic conditions.	ICFs offer a unique range of insulation choices, to meet the demands of all climate zones. Thermal modeling of the building will make the choice of R-value (or U-value) easier by providing information to support a calculation of energy saved versus added cost of higher insulation values.
Conductive Heat Transfer	The transfer of thermal energy directly through a building material, from a region of high temperature to an area of low temperature. CHT = TB	The continuous, unbroken, and high value insulation left in place by ICFs prevent “thermal bridging” in clear and undisturbed areas of ICF wall. This supports the thermal control capacity of the building as a whole, and reduces the “appetite for energy”.
Convective Heat Transfer	Convective heat transfer, or convection, is the transfer of heat from one place to another by the movement of fluids, like air or water. Examples are found in air leakage around doors and windows or heat rising through open areas of multi-story buildings (buoyancy).	Convective heat transfer (clear wall areas) is dramatically reduced in ICF buildings due to the air-impermeable layer of concrete that forms the core and structure of the building. A recent Canadian study attributes a 60% reduction in total air leakage to ICF construction.
Cooling Load	A building's calculated demand for energy generated by cooling requirements over seasonal cycles.	Because of built-in high levels of insulation and low levels of air infiltration, ICF structures will demonstrate a significantly lower “appetite for energy”, thereby reducing heating loads and cooling loads.
Cross-tie	An ICF term for the connector between the EPS panels of the ICF.	Criteria for ICF cross-ties are contained in CAN/ULC S717.1 STANDARD FOR FLAT WALL INSULATING CONCRETE FORM (ICF) UNITS.
CSA	Canadian Standards Association	The CSA Group, is a standards organization which develops standards in 57 areas.
Deflection	Deflection refers to a water management principle that utilizes features of the building and assembly geometry to limit the exposure of the assemblies to rain.	While generally exempt from added planes of protection from air and water, ICF/Concrete walls must be protected by an exterior finish layer to protect the EPS insulation. A secondary benefit of this is that a ‘deflection’ layer is provided.

Term	Definition	Relationship & Significance to ICF Products
Drainage	Drainage refers to a water management principle that utilizes surfaces of the assemblies to drain water away from the assembly.	ICF/Concrete wall assemblies may not require added drainage mechanisms due to the integrity of the concrete core. However, certain window/door installation methods may require added drainage measures, such as membrane flashings that shed water to the exterior.
Dew Point	The dew point is the temperature at which the air can no longer hold all of its water vapor, and some of the water vapor must condense into liquid water. The dew point is always lower than (or equal to) the air temperature.	Given the proper thickness of EPS panel(s) on the exterior side of the wall (driven by climate zone), the "dew point" should fall near the surface of the exterior EPS, where there is no cavity to trap moisture, or air flow to move moisture. Therefore, "dew point" is not an issue in a properly designed ICF wall.
Drying Capacity	The drying capacity of a wall assembly is its natural ability to drain and/or diffuse water and water vapor, if and when water may enter the structure due to damage to the exterior plane of protection. Sufficient (even redundant) means of drying and water escape should be part of every durable and sustainable building design.	ICF/Concrete walls exhibit relatively high "drying capacity" by nature. If exposed to water ICF walls will, first, retain very little water, and second, dry in two directions (exterior and interior) by means of slow water diffusion through and around the panels. In addition, concrete will absorb and use certain amounts of water during the hydration process and will permit some water to diffuse to the interior of the building, where it will be removed by the HVAC system.
Durability	The inherent ability of built structure to withstand deterioration due to natural and man-made forces which can degrade the structural and aesthetic quality of the building. Examples include rot caused by high moisture conditions, wind and seismic damage, and wear from occupant use.	ICF/Concrete structures, by their very nature, are among the most durable in the construction industry. The combination of steel-reinforced concrete with permanent EPS insulation makes structures highly resistant to natural and man-made destructive forces, like earthquakes, fire, water, mold, and daily wear.
EIFS	Exterior Insulation and Finishing System (typically acrylic stucco)	EPS in ICF panels can be used as a substrate for EIFS systems.
Embodied Energy	Total amount of energy required to produce and deliver a given building component. Includes mining and milling, finishing, and transport to site.	As a construction material, Expanded Polystyrene has been shown to have the potential to save 150 times the energy used to produce it, over a 50 year lifespan, as insulation. This gives EPS a low ratio of 1:150.

Term	Definition	Relationship & Significance to ICF Products
EnerGuide	EnerGuide is the official Government of Canada mark associated with the labeling and rating of the energy consumption or energy efficiency of specific products. EnerGuide labeling exists for appliances, heating and cooling equipment, houses and vehicles	As national and provincial building codes evolve, Energuide is becoming the preferred benchmark for thermal performance. ICF- built structures will achieve higher benchmarks with little or no added cost compared to wood walls. Therefore, the cost premium that has existed between ICF and wood structures is shrinking, or has disappeared altogether.
Energy Management Plan	Written specifications aimed at Thermal Control, conceived and added by designers to building plans and their supporting documents.	The degree of thermal control made possible by using ICF products (high insulation values + air-tightness) is one of the highest impact tools available to designers in reaching the goals of their Energy Target, be it local or national codes, LEED, EnergyStar or other standards.
Energy Modeling	A computer driven simulation of the thermal performance of a building over the span of a year, using different variables for characteristics like building orientation, insulation levels, amount of air infiltration through the building enclosure, and more. Used for cost/benefit analysis of building materials and methods.	ICFs offer a unique range of insulation choices, to meet the demands of all climate zones. Thermal modeling of the building will make the choice of R-value (or U-value) easier by providing information to support a calculation of energy saved versus added cost of higher insulation values. In addition, the assumed rate of air infiltration in an ICF building can be much lower, due to the impermeability of the concrete. The result is lower heating and cooling loads, or a smaller "appetite for energy".
Energy Target	A written objective for building performance and energy consumption. May be standardized in building codes or local and national programs like LEED, Green Globes, BuiltGreen, EnergyStar, EnerGuide and others.	The degree of thermal control made possible by using ICF products (high insulation values + air-tightness) is one of the highest impact tools available to designers in reaching the goals of their Energy Target, be it local or national codes, LEED, EnergyStar or other.

Term	Definition	Relationship & Significance to ICF Products
EOR	Engineer of Record; The engineer responsible for all structural aspects of a building design.	ICFs were designed specifically to conform to typical concrete wall designs found across the construction industry. The wall thickness and reinforcing requirements are generally the same as those found in concrete walls formed by removable forms. National and local codes in the US and Canada have adopted ICFs as part of their prescribed building assemblies, and engineers can incorporate ICFs into a design by using typical engineering standards, such as ACI 318 and ACI 347.
EPD	Environment Product Declaration	In life cycle assessment, an Environmental Product Declaration (EPD) is a standardized way of quantifying the environmental impact of a product or system. An EPD is created and verified in accordance with the International Standard ISO 14025, developed by the International Organization for Standardization (ISO).
EPS	Expanded Polystyrene Foam created by expanding beads in a mold using steam.	ICFMA members offer only EPS that has been evaluated and tested according to national and regional building code criteria.
Face Seal	Face Seal refers to a strategy for rain penetration control that relies on the elimination of holes through the cladding. Both weather resistant membrane (WRB) and EIFS stucco are examples of 'face seal' systems.	ICF/Concrete walls are "mass" walls that are exempt from added planes of protection from air and moisture penetration in US and Canadian codes. Therefore, a WRB is not required. EIFS and hard-coat stucco can be direct-applied to ICF EPS.
Fastening Strip	Plastic strips within and ICF used for the attachment of finishes, typically spaced at 6" (150mm) to 8" (200mm) on center.	Fastening Strips in ICFs are tested under national materials standards for pull-out and shear values, as well as acceptable performance in fire conditions.
FEMA	Federal Emergency Management Agency (US)	ICF/Concrete walls can support building designs done under FEMA criteria.
Flame spread index	An index or classification indicating the extent of the spread of flame on the surface of a material or assembly under specified testing conditions	All EPS products offered by ICFMA member firms are tested under national and regional code requirements for flame spread.

Term	Definition	Relationship & Significance to ICF Products
Flashing	Flashing refers to materials used to deflect water and make waterproof connections at interfaces and joints within and between wall and roof assemblies, including doors and windows.	ICF/Concrete walls have been tested to the most extreme climate conditions in order to establish “best-practice” methods for creating and sealing penetrations through ICF/Concrete walls. Contact the ICFMA for a summary of best practices.
Flat Wall	Monolithic flat concrete within the ICF wall cavity	ICFMA member firms offer “flat-wall” ICF designs in order to easily accommodate criteria in major concrete design codes, like ACI 318 and CAN/CSA A23.3
Form unit	One ICF unit or block	ICFs are typically of either a “block” or “panel” design
FRR	Fire Resistance Rating	ICFMA member firms have all performed testing to establish the FRR of various wall assemblies, generally from 2 to 4 hours.
Heating Load	A building's calculated demand for energy generated by heating requirements over seasonal cycles.	Because of built-in high levels of insulation and low levels of air infiltration, ICF structures will demonstrate a significantly lower “appetite for energy”, thereby reducing heating loads and cooling loads.
Housewrap	Housewrap refers to a sheet plastic material which is used as a breather type sheathing membrane, generally between the wall sheathing material and the exterior cladding in wood or metal framed construction.	ICF/Concrete mass walls are recognized as a “complete assembly”, and are exempt from secondary planes of air and moisture protection in US and Canadian building codes.
HVAC	Heating, Ventilation and Air-Conditioning systems or equipment	The choice of an ICF/Concrete thermal enclosure has been shown to reduce the overall “appetite for energy” of the building, thereby necessitating smaller (less expensive) HVAC equipment.

Term	Definition	Relationship & Significance to ICF Products
IAQ	Indoor Air Quality. This term refers to the comfort and safety levels experienced by the occupants of the building, as a result of the conditioning and handling of air supplies within the building shell. Features like constant air temperature and low levels of particulates (dust, mold, pollen, or pollutants) are seen as desirable conditions in occupied spaces. Uncontrolled air leakage in the building shell may lower the Indoor Air Quality.	Properly constructed, the “clear-wall area” constructed with ICFs has zero air porosity. This has been proven to reduce the “whole-wall” level of air leakage by 60%, without special attention to door/window openings, etc. This is an extremely high-impact tool for the designer in building an energy management plan.
IBC	International Building Code (US)	ICFMA member firms all offer products that have been evaluated to current US and Canadian residential and commercial building codes.
ICC	International Code Council (US)	ICFMA member firms all offer products that have been evaluated to current US and Canadian residential and commercial building codes.
ICF	Insulating Concrete Form	
IECC	The International Energy Conservation Code (IECC) is a building code created by the International Code Council in 2000. It is a model code adopted by many state and municipal governments in the United States for the establishment of minimum design and construction requirements for energy efficiency.	New energy codes in the USA and Canada are calling for both higher levels of insulation, and “continuous” insulation across the building shell. ICF/Concrete buildings are able to meet these updated codes without added cost to the structure, since both features have been in place from the start. Cavity wall builders will face significant increases in their costs as they add more material and labor to meet new codes.
Interface Details	Construction details specific to the point at which two or more building components must join in order to prevent air or water leakage, thermal bridging, or structural interruption. Examples are window flashing details, wall- to-floor or wall-to- roof	ICFMA member companies have made detailed technical information available to the public, in the form of construction details, product manuals, videos and technical bulletins.

Term	Definition	Relationship & Significance to ICF Products
IRC	International Residential Code (US)	ICFMA member firms all offer products that have been evaluated to current US and Canadian residential and commercial building codes.
Interlock	The crenelation on the top and bottom of an ICF panel that is designed to interlock the forms together.	ICF interlocks help to stabilize the forms during wall assembly and pouring of concrete. Some interlocks are reversible.
Kwh	The kilowatt hour (Kw/h) is a unit of electric energy equal to 1000 watt/hours.	ICFs offer a unique range of insulation choices, to meet the demands of all climate zones. Thermal modeling of the building will make the choice of R-value (or U-value) easier by providing information to support a calculation of energy saved versus added cost of higher insulation values.
LEED	Leadership in Energy and Environmental Design	ICF/Concrete walls can contribute to accreditation under LEED via improvements in performance of the building envelope and the materials themselves.
Lift	A limited height term used for continuous concrete placement in an ICF, typically a maximum of 4' (1220mm)	Most ICFs are evaluated under a 4 ft. [1.22 m] per hour pour rate.
Lintel	The engineered portion of the wall directly over and around an opening	The 'flat-wall' ICF design offered by ICFMA member firms allows for construction of lintels according to standard concrete design principles.
Load	A supported weight of mass.	ICF/Concrete walls are designed to resist loads in the same manner as any other cast-in-place concrete wall.
Load bearing	A building element subjected and designed to support live and dead loads.	ICF/Concrete walls can be designed as either non-load bearing walls or bearing walls, to maximum calculated loading conditions.
Mass Wall	Walls constructed from masonry, precast or cast-in-place concrete are considered to be mass walls	ICF/Concrete walls are cast-in-place mass walls and are considered to be complete assemblies, therefore generally exempt from additional planes of protection from air and moisture penetration

Term	Definition	Relationship & Significance to ICF Products
Moisture Barrier	A layer of plastic or foil which resists the diffusion of moisture through wood and steel cavity wall, ceiling, and floor assemblies.	ICF/Concrete walls are generally exempted by building codes from moisture barriers (like building paper and Tyvek) because building codes recognize "mass" walls, or concrete walls, as being water resistant by nature.
NBC	National Building Code of Canada	The National Building Code of Canada is issued by National Research Council Canada.
Net-Zero Energy	A popular term used to describe buildings that demonstrate a balance between energy consumption and production over the span of a year, or a "net-zero" rate of consumption of energy produced for the public grid.	The achievement of "Net-Zero" energy consumption requires that a building exhibits a dramatically reduced "appetite for energy" than most structures built over the last 100 or more years. ICF structures can easily support this level of thermal performance. With the addition of on-site produced energy sources and other technologies (some yet-to-come), a building can achieve "net-zero" performance. Many examples are already been built in or through our client base.
Net-Zero Ready	A term that describes a structure that currently demonstrates the level of thermal control in the building shell necessary to support "Net-Zero" energy consumption, even at some time in the future when improved systems and on-site energy production are added.	The levels of performance in the building shell necessary to support "Net-Zero" levels of energy consumption are already being designed and built across the USA, Canada, and Europe. The combination of high insulating values and low air infiltration make ICF walls/floors/roofs the natural choice for PassivHaus and other energy-efficient building formats.
NRMCA	National Ready Mix Concrete Association	ICFMA member firms work in close cooperation with Ready-Mix Concrete Producers in the US and Canada.
Operation (of the Building or Envelope)	Operation refers to normal occupancy of the building where the envelope is affected by local climate, interior space conditioning, changes to light fixtures, signs, vegetation and planters, and accidental damage or vandalism.	Dollar for dollar, ICF/Concrete buildings are proven to operate more efficiently and exhibit better resilience than competing construction technology.
Pa	Pascal, unit of pressure	ICFMA member firms have all performed required testing under ASTM and other national criteria, using standard units of measurement.

Term	Definition	Relationship & Significance to ICF Products
PCA	Portland Cement Association	ICFMA member firms work in close cooperation with Ready-Mix Concrete and cement producers in USA and Canada
Penetration	Penetration refers to a intentional opening through an assembly in which ducts, electrical wires, pipes, and fasteners are run from inside to outside.	ICF/Concrete walls can accommodate any manner of penetration using known, tested, and available materials and methods. ICFMA member firms publish installation manuals that detail the necessary elements.
Permeance	The water vapor transmission coefficient for a material.	ICF/Concrete walls are recognized in US and Canadian building codes as a water resistant assembly, without the need for added layers of moisture protection, including against vapor transmission.
Placement	The act of setting concrete or rebar in an ICF wall cavity.	ICFMA member firms offer products with built-in guides for placement of concrete or rebar within the wall cavity.
Prescriptive Design	Standardized construction specifications (both structural and energy related) contained in local and national building codes that can be included in building plans without review by a licensed engineer. Used to gain plan approval in buildings that fall within certain size and storey parameters spelled out in the code. (Mostly residential)	National and local codes in the US and Canada have adopted ICFs as part of their "main-stream" prescribed building assemblies for residential structures. Both the US (International Residential Code, Ch. 4 and Ch. 6) and Canada (National Building Code of Canada, Part 9) feature acceptable specifications under which residential buildings can be constructed without review by an engineer. State, Provincial, and local codes are usually modeled after these same codes, and thereby encourage ICF construction.
R-Value	R-Value is a measure of thermal resistance, or how well a building material is likely to resist heat flow. A higher R-value means lower heat loss. R-value is the reciprocal of U-value.	ICFs offer a unique range of insulation choices, to meet the demands of all climate zones. Thermal modeling of the building will make the choice of R-value (or U-value) easier by providing information to support a calculation of energy saved versus added cost of higher insulation values.

Term	Definition	Relationship & Significance to ICF Products
Rainscreen	Rainscreen refers to a strategy for rain penetration control for wood and metal framed buildings that relies on deflection of the majority of water at the cladding, but also incorporates a cavity which provides a drainage path for water that penetrates past the cladding.	ICF/Concrete walls are recognized in US and Canadian building codes as a water resistant assembly, without the need for added layers of moisture protection, including rainscreen. Rainscreen may be advisable on ICF/Concrete walls if required as a condition or warranty by manufacturers of exterior finish materials.
Rebar	Reinforcement bars (usually steel)	ICFs are reinforced with deformed steel reinforcement bars according to design principles offered in major code criteria, such as ACI and CAN/ULC.
Replacement Interval	(Also: Useful Life, Service Life) The amount of time between construction of a building and the point at which it must be replaced. Also pertains to the time between installation of building equipment or components and the end of their service life.	The high degree of durability (long life-span) inherent in ICF/concrete structures makes the "replacement interval" much longer. When this longer interval is amortized into the Life Cycle Cost Analysis (LCCA), both the annual cost of ownership and the average annual level of carbon emissions go down.
ROI	Return on Investment: A financial calculation of the annual rate of return to be gained by investment in specific building features, like ICF construction, solar generation equipment, or high-efficiency HVAC equipment. Ideally, a 100% recovery of investment dollars comes in the shortest possible time.	ICFs offer a unique range of insulation choices, to meet the demands of all climate zones. Thermal modeling of the building will make the choice of R-value (or U-value) easier by providing information to support a calculation of energy saved versus added cost of higher insulation values. In addition, the assumed rate of air infiltration in an ICF building can be much lower, due to the impermeability of the concrete. The result is lower heating and cooling loads, or a smaller "appetite for energy" reducing costs and generating more ROI.
RSI	R-Value System International. Metric thermal resistance index	ICFMA member firms offer products that meet or exceed thermal insulation requirements for all climate zones in USA and Canada
SCM	Supplementary cementing materials used in a concrete mix design	SCMs can improve the pour characteristics in ICF walls, and are generally recommended by ICFMA member firms.

Term	Definition	Relationship & Significance to ICF Products
Sheathing Membrane	Sheathing Membrane refers to a material in an exterior wall assembly whose purpose is to retard penetration of water further into the structure once past the cladding.	ICF/Concrete walls are recognized in US and Canadian building codes as a water resistant assembly, without the need for added layers of moisture protection, including sheathing membrane.
Sheathing Paper	Sheathing Paper refers to asphalt impregnated organic sheet material (breather type sheathing membrane) which creates a water shedding surface behind the cladding.	ICF/Concrete walls are recognized in US and Canadian building codes as a water resistant assembly, without the need for added layers of moisture protection, including sheathing paper.
Solar Heat Gain	(Also: SHGC-Solar Heat Gain Coefficient; solar heat gain; passive solar gain) Solar Heat Gain refers to the increase in temperature in a space, object or structure that results from solar radiation. The amount of solar gain increases with the strength of the sun, and with the ability of any screening or insulating material to transmit or resist the radiation. Examples of items that reduce solar heat gain are trees, awnings, screens, and insulation on the exterior of the building.	Because ICFs offer variable thicknesses of insulation, the outer layer of insulation can be increased to the point where radiant heat gain in the concrete structure is at or near zero. The concrete then assumes the temperature of the interior of the building and the earth upon which the building rests. This is the desired condition in climates where solar heat gain is a concern, and will dramatically reduce cooling loads.
STC	Sound Transmission Classification, the classification rating of airborne sound that is inhibited from traveling through a material or assembly.	ICF/Concrete wall assemblies typically meet or exceed minimum STC requirements. Consult individual manufacturers for tested values.
Stirrup	A bent reinforcement bar in a 'C', 'O' or 'S' shape used in beams and lintels.	'Flat-wall' ICF form designs can accommodate most stirrup designs.
Therm	The therm (symbol thm) is a unit of heat energy equal to 100,000 British thermal units (BTU). It is approximately the energy equivalent of burning 100 cubic feet (often referred to as 1 CCF) of natural gas.	ICFs offer a unique range of insulation choices, to meet the demands of all climate zones. Thermal modeling of the building will make the choice of R-value (or U-value) easier by providing information to support a calculation of energy saved versus added cost of higher insulation values.

Term	Definition	Relationship & Significance to ICF Products
Thermal Break	A thermal break is an element of low thermal conductivity placed in an assembly to reduce or prevent the flow of thermal energy between conductive materials. Examples are found in slab-edge insulation, insulating sheathing placed on the exterior of wood or metal-stud walls, and the continuous layer of insulation offered by ICF walls.	ICF walls feature both a continuous layer and variable thickness of insulation (inside and out), which can be increased on the exterior to meet the needs of a more extreme climate zones.
Thermal Bridge	A pathway for heat; Any point at which a high rate of unwanted heat flow can occur across the building enclosure cross-section. Examples are found in uninsulated posts, studs, and headers in wood buildings, and exposed exterior concrete building elements that are also exposed to interior conditioned space.	(See “Thermal Break”) ICF structures, by nature, create almost no instances of thermal bridging because the two layers of insulation are continuous and unbroken, creating “thermal continuity”. The exception (generally) occurs at doors and windows, where additional measures can be taken to reduce thermal bridging.
Thermal Continuity	A condition in the building enclosure where a layer of unbroken insulation exists across as much of the exterior face of the building as possible, eliminating thermal bridging.	(See “Thermal Break”) ICF structures, by nature, create almost no instances of thermal bridging because the two layers of insulation are continuous and unbroken, creating “thermal continuity”. The exception (generally) occurs at doors and windows, where additional measures can be taken to reduce thermal bridging.
Thermal Control System	All components in the building dedicated to thermal control and occupant comfort. Includes items like heating and air conditioning systems, exterior insulation, shading devices, windows and doors.	ICFs remain in place to provide a key component in the thermal enclosure; Unbroken layers of permanent insulation that can be varied in thickness to meet the climatic conditions of the building site.
Thermal Enclosure	(Also; Thermal Shell, Insulating Layer) Elements in the building enclosure that are dedicated to control of heat flow through the plane of the building enclosure. Usually excludes structural elements, unless they are part of the thermal control system, like ICF and SIP walls.	ICFs remain in place to provide a key component in the thermal enclosure; Unbroken layers of permanent insulation that can be varied in thickness to meet the climatic conditions of the building site.

Term	Definition	Relationship & Significance to ICF Products
Thermal mass	The concrete mass within the wall assembly that influences the temperature transmission through the wall assembly.	ICF/Concrete walls are proven to offer significant benefits in both energy efficiency and resilience, due to the high mass of the wall assembly.
U-Value	A measurement of the rate of thermal conductivity of a building material, or how much heat loss is likely to occur. A lower U-value means lower heat loss. U-value is the reciprocal of R-Value.	ICFs offer a range of insulation choices, to meet the demands of all climate zones. Thermal modeling of the building will make the choice of R-value (or U-value) easier by providing information to support a calculation of energy saved versus added cost of higher insulation values.
UL	Underwriters Laboratories (US)	ICFMA member firms have all performed required testing under national criteria, by accredited testing agencies.
ULC	Underwriters Laboratories Canada	ICFMA member firms have all performed required testing under ASTM and other national criteria, using standard units of measurement. ICFMA member firms have all performed required testing under national criteria, by accredited testing agencies.
Uncontrolled Air Leakage	(Also: Porosity) Air flow entering or leaving the building via gaps and holes in the thermal enclosure which do not support the planned rate of air exchange calculated for the building. May be driven by wind acting on the exterior of the building, stack-effect (buoyancy) within the building, or improperly sized ventilation equipment.	Properly constructed, the "clear-wall area" constructed with ICFs has ZERO air porosity. This has been proven to reduce the "whole-wall" level of air leakage by 60%, without special attention to door/window openings, etc. This is an extremely high-impact tool for the designer in building an energy management plan.
Vapor Barrier	Typically, a 6mil poly film, installed on the interior face of the exterior wall to control the diffusion of water vapor.	ICF/Concrete walls are recognized in US and Canadian building codes as a water resistant assembly, without the need for added layers of moisture protection, including against vapor transmission.

Term	Definition	Relationship & Significance to ICF Products
Web	Terminology for the ICF cross-tie connecting the EPS panels	Criteria for ICF cross-ties are contained in CAN/ULC S717.1 STANDARD FOR FLAT WALL INSULATING CONCRETE FORM (ICF) UNITS.
Wetting Capacity	The wetting capacity of a wall assembly is its ability to allow unwanted moisture intrusion (both bulk water and water vapor) and its ability to then store all or part of that moisture. A high wetting capacity is undesirable because of problems created by water within a wall or floor structure, like rot, mold, insect infestation, and reduction of insulating value.	ICF/Concrete walls are water resistant by nature. First, the solid concrete plane in the center of the wall is considered to be a water resistant plane, on its own, by most building codes. Second, the layer of EPS insulation on the exterior of the concrete wall has little capacity to pass or store water and water vapor. The combination of the two materials results in a wall assembly with very low "wetting capacity".
Whole Wall Area	A term used in building enclosure science to denote an area of wall that contains all elements common to built structures, including windows, doors, and corners.	As a main component in a building's "whole-wall area", ICFs & concrete contribute enough positive impact (energy conserving) on thermal performance to offset the negative contributions (energy wasting) of other components, like windows, doors, corners & etc. This is especially true in contrast to wood or steel cavity walls and uninsulated masonry walls.

8.0 Case Studies

8.1 Residential Multi-Storey - Brownstones at MayFair Park

TYPE OF BUILDING: Residential, Multi-Family

SIZE OF PROJECT: 90,000 sq. ft.

LOCATION OF PROJECT: Oklahoma City, Oklahoma

YEAR BUILT: 2008

ICF SYSTEM USED: BuildBlock ICF

- ▲ ICF combined with geothermal active system, passive shading and ventilation options make these homes remarkable efficient in energy consumption
- ▲ Project used 90,000 sq.ft. of ICF block in this 28 acre development.
- ▲ The row houses were designed around the ICF system to maximize the benefit of the load bearing and insulating qualities of ICF
- ▲ These \$1 million homes are located within a few blocks of the main North-South rail line through downtown, so acoustic control properties from outside the homes and between the homes were extremely important.
- ▲ ICF allowed clear spanning between party walls and allowed for maximum flexibility of interior planning
- ▲ Masons used hydraulic scaffolding to finish the brick exterior while framers worked simultaneously on the interior.
- ▲ Construction proceeded simultaneously on multiple units at 1 level per week.



8.2 Retail/Commercial - Enermodal Headquarters

TYPE OF BUILDING: Commercial Office

LOCATION OF PROJECT: Kitchener, Ontario

YEAR BUILT: 2011

ICF SYSTEM USED: NUDURA ICF

- ▲ The goal of the Enermodal building, headquarters in Kitchener Ontario, was to create a healthy work environment for employees in a building that uses 80% less energy than any other office country.
- ▲ NUDURA Insulated Concrete Forms used for this structure provided superior insulation for healthy indoor air quality. Ventilation air is delivered separately from heating and cooling function to ensure excellent indoor air quality without over or under heating
- ▲ The latest technology in heating and cooling was used: heat pumps that operate continuously at a low speed. Active daylighting, automated exterior shades, and motion sensors were other key aspects to the design
- ▲ 89% of site waste was diverted from the landfill to recycling facilities

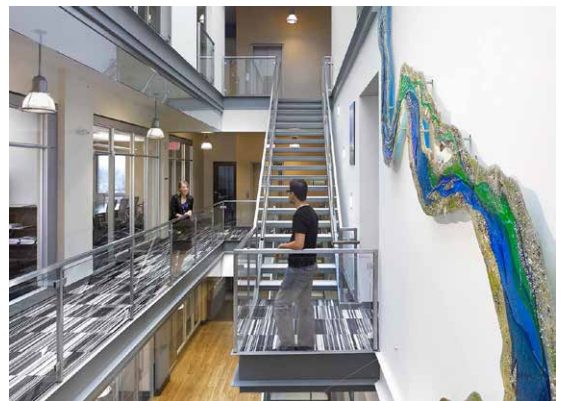

8.3 Institutional - Gilchrist Seniors' Residence

TYPE OF BUILDING: Institutional

SIZE OF PROJECT: 50,000 sq. ft.

LOCATION OF PROJECT: Calgary, AB

YEAR BUILT: 2015

ICF SYSTEM USED: Logix ICF

- ▲ This 4-storey structure includes an ICF basement. Each storey was built with 9'8" Logix wall. Hambro floors were used.
- ▲ First ICF project over 4-stories built in the city of Calgary using ICFs with plastic webs.
- ▲ The ICF construction portion was completed on time and on schedule. Unexpected engineering issues were encountered and resolved - footings had to be stepped down further than originally planned.
- ▲ This project was an initiative of (and is owned by) the Alberta government to make seniors' housing more affordable by reducing the ongoing heating and cooling portion of the monthly fees paid by the residents.
- ▲ 10 years after the project, ownership has not changed drastically (same owners)



8.4 Hospitality - La Concha Peal

TYPE OF BUILDING: Hospitality, Hotel

SIZE OF PROJECT: 84,000 sq. ft.

LOCATION OF PROJECT: La Paz, Mexico

YEAR BUILT: 2008

ICF SYSTEM USED: Quad-Lock

- ▲ 33 Luxury Beachfront Condominiums designed to withstand Cat 5 hurricane and zone 4 earthquakes
- ▲ 66% Estimated Energy Savings
- ▲ 62,000 sq. ft. of Quad-Lock Walls and 84,000 sq. ft. across 7 Quad-Deck Floors
- ▲ 3775 cu. yd. of Concrete Mix
- ▲ 8 Months ICF Start to Finish
- ▲ Each story had rebar installed



8.5 Medical - Norton Pediatric Center

TYPE OF BUILDING: Medical

SIZE OF PROJECT: 70,040 sq.ft.

LOCATION OF PROJECT: Louisville, Kentucky

YEAR BUILT: 2011

ICF SYSTEM USED: NUDURA ICF

- ▲ Norton Pediatric is a pediatric outpatient center built to hospital standards.
- ▲ The 70,040 square foot facility built with NUDURA Insulated Concrete Forms includes a 24-hour emergency department, diagnostic imaging including MRI, CT and Ultrasound. The surgery department and central sterile supports four operating rooms and two future planned operating room additions.
- ▲ This facility will be LEED® Certified and is designed to meet ENERGY STAR requirements.



8.6 Military - Kirkland Flight Simulator Building

TYPE OF BUILDING: Military
SIZE OF PROJECT: 13,186 sq. ft.
LOCATION OF PROJECT: New Mexico
YEAR BUILT: 2013
ICF SYSTEM USED: NUDURA ICF

- ▲ A \$9M Flight Simulator Facility constructed with ICF and located at the Air Force Base in Kirtland, New Mexico.
- ▲ NUDURA Insulated Concrete Forms contributes to the project's LEED Silver Certification where it improved overall energy efficiencies.
- ▲ ICFs were used for the tall simulator bay walls and all the exterior walls of the lower administration area.
- ▲ The forms added to the structure's strength, longevity & energy efficiency. The walls are all bearing for the roof joist system and are fire retardant. They are non-toxic and do not emit CFC's or HCFC's.
- ▲ Other factors that contribute to LEED are: water efficient landscaping, enhanced commissioning & refrigerant management, waste recycling & thermal comfort design.



Summary

In summary, the ICFMA hopes that this Design Guide has helped identify the framework of factors for selecting insulating concrete forms as the building material for your next multi-storey project.

In the case of a conflict between these guidelines and a specific manufacturers guidelines, the ICF manufacturers guidelines will take precedent.

For more information about the ICFMA, it's members and what is available to help make designing your next project with ICFs easier visit the website at icf-ma.org.

References & Contributors

Kevin Davis - ICFMA Technical Chair

Tom Patton - PattonTech

Douglas Bennion – Quad-Lock Building Systems

Keven Rector - NUDURA Inc.

Francis Roma – Logix Insulated Concrete Forms Ltd

Kelvin Doerr – Fox Blocks

Max Isaac – Superform Products Ltd

Brian Corder – BuildBlock Building Systems, LLC



Visit icf-ma.org for more information or to download a PDF copy of this guide. All information within this guide is the property of the ICFMA and it's primary members.

The information contained in this ICFMA Design Guide is presented only for the purpose of providing information on designing with insulating concrete forms. This ICFMA Design Guide SHALL NOT be used as a substitute for professional engineering consultation. ICFMA makes no general warranties to the specific applicability of any of the products to any or all situations for which a designer may elect their specific use. Final amendment or modification to suit the exact circumstance of employment of any such products is the responsibility of the project designer. ICFMA has no control over the installation or workmanship used in the assembly or installation of the insulating concrete form products. Therefore, ICFMA cannot be held liable for any general, special, direct, indirect or consequential damages, including bodily harm, that may be suffered by any person including, without limitation, the installer, contractor, architect, engineer, homeowner or building owner due to the use, assembly or installation of the insulating concrete forms based off the ICFMA Design Guide.